

STAFF SELECTION COMMISSION

STENOGRAPHER GRADE C & D EXAMINATION

SOLVED PAPER

(10th December 2024: Shift-1)

Time Allotted- 2 hours

Max marks- 200

General Intelligence & Reasoning

- Select the set in which the numbers are related in the same way as the numbers of the following set.
(9, 83, 164)
(4, 18, 34)
(NOTE: Operations should be performed on the whole numbers, without breaking down the numbers into its constituent digits. For example, 13 – Operations on 13 such as adding/subtracting/multiplying, etc. to 13 can be performed. Breaking down 13 into 1 and 3 and then performing mathematical operations on 1 and 3 is not allowed.)

1. (5, 27, 56) 2. (6, 38, 74)
3. (11, 122, 242) 4. (13, 167, 334)
- Three statements are given, followed by two conclusions numbered I and II. Assuming the statements to be true, even if they seem to be at variance with commonly known facts, decide which of the conclusion(s) logically follow(s) from the statements.

Statements:
Some teachers are dancers.
All dancers are beautiful.
All teachers are honest.

Conclusions:
I. Some teachers are beautiful.
II. Some dancers are honest.

1. Only Conclusion II follows.
2. Only Conclusion I follows.
3. Both Conclusions I and II follow.
4. Neither Conclusion I nor II follows.
- Select the option in which the numbers are related in the same way as the numbers in the given set.
(2, 7, 11)
(13,17,29)
(NOTE: Operations should be performed on the whole numbers, without breaking down the numbers into its constituent digits. For example, 13 – Operations on 13 such as adding/subtracting/multiplying, etc. to 13 can be performed. Breaking down 13 into 1 and 3 and then performing mathematical operations on 1 and 3 is not allowed.)

1. (3, 9, 11) 2. (13, 17, 23)
3. (37, 41, 49) 4. (27, 31, 33)
- Select the pair which is related to each other in the same way as the following –
12 : 168
11 : 145
(NOTE: Operations should be performed on the whole numbers, without breaking down the numbers into its constituent digits. For example, 13 – Operations on 13 such as adding/subtracting/multiplying, etc. to 13 can be performed. Breaking down 13 into 1 and 3 and then performing mathematical operations on 1 and 3 is not allowed.)

1. 14 : 172 2. 5 : 61 3. 16 : 232 4. 8 : 88

- Which two signs and which two numbers (not digits) should be interchanged to yield the value 'zero' for the following expression?
1. + and ÷; 11 and 18 2. × and – ; 4 and 11
3. – and ÷; 2 and 4 4. + and ÷; 2 and 18
- Which of the following numbers will replace the question mark (?) in the given series?
5, 14, 41, 122, 365, ?
1. 1049 2. 1490 3. 1940 4. 1094
- Select the option figure that will replace the question mark (?) in the figure given below and complete the pattern.

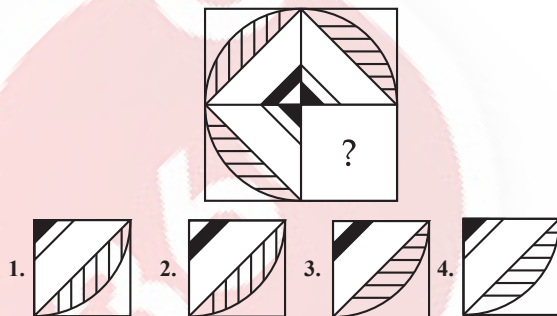

- Select the option in which the given figure (X) is embedded (rotation is NOT allowed).

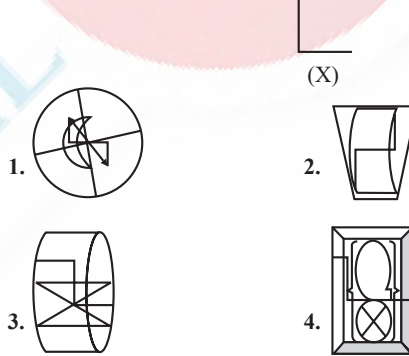

- A, B, C, X, Y and Z are sitting around a circular table facing the centre (but not necessarily in the same order). X sits immediately to the left of A. Only one person sits between X and Z. C sits second to the right of B. Y is not an immediate neighbour of A. Who is sitting immediately to the right of Z?
1. C 2. A 3. Y 4. B
- Select the figure from among the given options that can replace the question mark (?) in the following series.

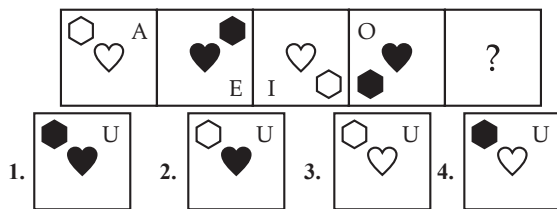

11. Given below is a statement followed by two conclusions I and II. Study the statement carefully and decide which conclusion/s is/are definitely true.

Statement:

$$M > N \geq O \leq P \leq W; X \geq O > Y$$

Conclusions:

I. $M > X$

II. $Y < W$

1. Only Conclusion I is true.
2. Only Conclusion II is true.
3. Neither Conclusion I nor II is true.
4. Both Conclusions I and II are true.

12. What will come in the place of the question mark (?) in the following equation if '+' and '-' are interchanged and '×' and '÷' are interchanged?

$$108 \times 2 - 14 \div 6 + 27 = ?$$

1. 212
2. 114
3. 111
4. 101

13. How many parallelograms are there in the figure given below?

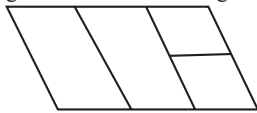

1. 8
2. 7
3. 9
4. 10

14. In this question, three statements are given, followed by three conclusions numbered I, II and III. Assuming the statements to be true, even if they seem to be at variance with commonly known facts, decide which of the conclusion(s) logically follows/follow from the statements.

Statements:

All pants are shirts.

All shirts are jackets.

Some jackets are sweaters.

Conclusions:

I. Some jackets are pants.

II. Some sweaters are shirts.

III. No pant is a sweater.

1. None of Conclusions I, II or III follows.

2. Both Conclusions I and II follow.

3. Both Conclusions II and III follow.

4. Only Conclusion I follows.

15. What should come in place of the question (?) in the given series based on the English alphabetical order?

IGK, LJN, OMQ, RPT, ?

1. USW
2. VRW
3. URW
4. VSW

16. Select the triad from the given options that is analogous to the given triad.

$$505 - 604 - 217$$

$$1. 432 - 513 - 711$$

$$2. 161 - 512 - 710$$

$$3. 125 - 223 - 342$$

$$4. 244 - 226 - 262$$

17. Five houses (A, B, C, D, and E) are located equidistant from each other in such a way that B is to the East of A, D is to the South of B, C is to the West of D, and E is to the South of C. In which direction is A to E?

1. West
2. South-West
3. North
4. North-East

18. What will come in place of the question mark (?) in the following equation if '+' and '×' are interchanged and '-' and '÷' are interchanged?

$$5 + 3 \times 2 \div 10 - 5 = ?$$

1. 12
2. 10
3. 13
4. 15

19. Which of the following equations is correct when the numbers 3 and 9 are interchanged and the signs - and × are interchanged?

$$1. 12 \div 9 - 2 \times 7 + 3 = 10$$

$$2. 1 - 9 \times 10 \div 4 + 3 = 32$$

$$3. 9 \div 4 \times 3 + 1 - 6 = 18$$

$$4. 9 \div 2 \times 1 - 3 + 5 = 15$$

20. Which letter cluster will replace the question mark (?) to complete the given series?

WGDE, ZEGC, ?, FAMY, IYPW

1. DBJC

2. DCIB

3. CCJA

4. ZCIB

21. Three of the following four are alike in a certain way and thus form a group. Which one does NOT belong to that group?

(NOTE: The odd one out is not based on the number of vowels or consonants in the word).

1. DFA

2. PRM

3. IKF

4. SUQ

22. Two statements are given, followed by two conclusions numbered I and II. Assuming the statements to be true, even if they seem to be at variance with commonly known facts, decide which of the conclusion(s) logically follow(s) from the statements.

Statements:

Some flowers are buds.

Some flowers are trees.

Conclusions:

I. Some trees are buds.

II. No tree is a bud.

1. Neither Conclusion I nor II follows.

2. Both Conclusions I and II follow.

3. Only Conclusion I follows.

4. Only Conclusion II follows.

23. If × means ÷, ÷ means -, - means +, and + means ×, what will be the value of the given expression?

$$7 + 5 \div 3 - 12 \times 4$$

1. 28

2. 30

3. 6

4. 35

24. Which of the following numbers will replace the question mark (?) in the given series?

122, 135, 161, 200, 252, ?

1. 217

2. 417

3. 317

4. 517

25. Select the number from the given options that can replace the question mark(?) in the following series.

12, 16, 25, 50, 99, ?, 389

1. 200

2. 220

3. 240

4. 180

26. Select the option that is embedded in the given figure (rotation is NOT allowed).

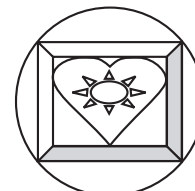

27. Suresh is now 19 years old and in college. Since he was 5 years old, he stayed in a hostel and is now coming back home after 14 long years. His parents have texted him the direction from the railway station to his house. See the text message below, sent to Suresh by his parents, and answer the following question accordingly.

“When you step out of the railway station, you will be facing north. Take a right and drive 4 km; you will see a T-point/junction. Take a right and drive 2 km. There will be a round about with four roads. Take the second left from the roundabout and drive 1 km. Take a right and drive 3 km. Take a left and drive 2 km. You will find our house directly ahead. Come home fast.”

How many kilometres did Suresh drive after taking the second-left from the roundabout to reach his home by following the directions given by his parents?

1. 12 2. 6 3. 8 4. 5
28. If X is the sister of Y, Z is the father of A and Y is the son of A, then how is Z related to X?
 1. Great grandfather 2. Granddaughter
 3. Father 4. Grandfather
29. What will be the day of the week on 14 September 3041?
 1. Monday 2. Tuesday
 3. Friday 4. Sunday
30. Select the pair from the given options that is analogous to the given pair.
 14 : 200
 5 : 29

(NOTE: Operations should be performed on the whole numbers, without breaking down the numbers into its constituent digits. For example, 13 – Operations on 13 such as adding/subtracting/multiplying, etc. to 13 can be performed. Breaking down 13 into 1 and 3 and then performing mathematical operations on 1 and 3 is not allowed.)

1. 11 : 120 2. 15 : 230 3. 7 : 50 4. 16 : 260
31. In a certain code language, 'BOOK' is coded as 172 and 'PAGES' is coded as 240. How will 'LIBRARY' be coded in the same language?
 1. 680 2. 510 3. 469 4. 595
32. Six friends are playing a bottle-spinning game around a circular table, all facing the centre. Rohini is seated third to the left of Rashmi. Rahul is seated in between Rashmi and Ramesh. Ravi is seated in between Rohini and Raju. Ravi is seated second to the right of Rashmi. Who among the following is seated immediately to the left of Raju?
 1. Rashmi 2. Rohini 3. Ramesh 4. Rahul
33. Which of the following numbers will replace the question mark (?) in the given series?
 23, 54, 81, 117, 137, 182, 191, ?
 1. 249 2. 294 3. 245 4. 254
34. Which figure should replace the question mark (?) if the following series were to be continued?

B	=	4	U	R	4	B	=	?
O		=	U		4			
U	S	4	O	B	S	=	O	B
						U	R	O

1.

4	B
=	
O	U
R	
2.

O	B
=	
4	U
R	
3.

6	B
=	
4	U
R	
4.

U	B
	R
O	4
=	

35. Three of the following four letter clusters are alike in a certain way and one is different. Pick the odd one out.
 (NOTE: The odd one out is not based on the number of vowels or consonants in the word)
 1. FUHC 2. WDYT 3. JQLG 4. SHQP

36. 4 is related to 125 following a certain logic. Following the same logic, 8 is related to 729. Which of the following numbers is related to 1728 using the same logic?

(NOTE: Operations should be performed on the whole numbers, without breaking down the numbers into its constituent digits. For example, 13 – Operations on 13 such as adding/subtracting/multiplying, etc. to 13 can be performed. Breaking down 13 into 1 and 3 and then performing mathematical operations on 1 and 3 is not allowed.)

1. 11 2. 12 3. 10 4. 9
37. In a certain code language, 'PRICE' is coded as EGRTK and 'STAGE' is coded as IGUVVC. How will 'RIGHT' be coded in the same language?
 1. JVTKH 2. JVTKI 3. GRVJG 4. GRVKG
38. Select the option that is related to the third number in the same way as the second number is related to the first number and the sixth number is related to the fifth number.
 16 : 85 :: 23 : ? :: 28 : 145

(NOTE: Operations should be performed on the whole numbers, without breaking down the numbers into its constituent digits. For example, 13 – Operations on 13 such as adding/subtracting/multiplying, etc. to 13 can be performed. Breaking down 13 into 1 and 3 and then performing mathematical operations on 1 and 3 is not allowed.)

1. 135 2. 105 3. 120 4. 150
39. If L means ÷, N means ×, P means + and J means –, which of the following interchanges should be done to hold the given equation 19 L 95 N 5 J 35 P 7 = 333 true?
 1. (J and N) 2. (P and N) 3. (P and L) 4. (N and L)
40. Select the figure from the options that can replace the question mark (?) and complete the given pattern.

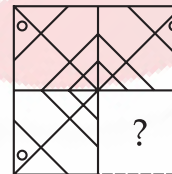

- 1.
- 2.
- 3.
- 4.

41. Among seven people, F, G, H, K, L, M and N, each has a different age. Only two people are older than M. Only two people are younger than K. The age of K is a multiple of 10. The youngest is 12 years old. F is the eldest. N is older than L but younger than H. L is not the youngest. The sum of the ages of the youngest and second oldest person is 42 years. What could be the possible age of L?
 1. 21 years 2. 10 years
 3. 15 years 4. 12 years
42. Select the numbers from the given options that can replace the question marks (?) in the same sequence and make the series logically complete.
 17, 18, 22, 31, ?, 72, ?, 157
 1. 49, 106 2. 45, 107 3. 47, 108 4. 47, 105

43. AZ 1 is related to CX 3 in a certain way based on the English alpha-numerical order. In the same way, EV 5 is related to GT 7. Following the same logic, to which of the following is IR 9 related?

1. KP 11 2. KQ 11 3. PK 11 4. MN 13

44. A is the mother of C who is not the son. C has a daughter E. A is married to F. F has a son B, who has a son, D. What is the relationship between D and E?

1. Daughter 2. Mother 3. Cousin 4. Sister

45. Which option represents the correct order of the given words as they would appear in an English dictionary?

a. Measurement b. Methodology
c. Merchandise d. Meaningless
e. Memorabilia

1. d, a, e, c, b 2. b, c, d, e, a
3. e, b, a, c, d 4. e, b, d, a, c

46. Choose a figure which would most closely resemble the unfolded form of the figure.

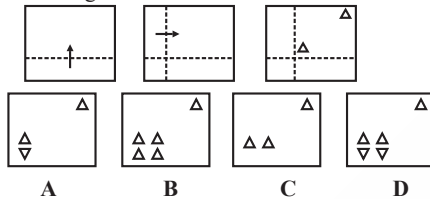

1. B 2. A 3. C 4. D

47. Three statements are given, followed by three conclusions numbered I, II and III. Assuming the statements to be true, even if they seem to be at variance with commonly known facts, decide which of the conclusion(s) logically follow(s) from the statements.

Statements:

Some fathers are females.

All fathers are males.

Some fathers are mothers.

Conclusions:

I. Some males are not females.

II. Some mothers are females.

III. Some males are mothers.

1. Only Conclusion III follows.

2. Both Conclusion II and III follow.

3. All Conclusions follow.

4. Both Conclusion I and III follow.

48. Select the term from the given options that can replace the question mark (?) in the following series.

GDA, OLI, WTQ, EBY, ?

1. NQP 2. KMN 3. MJG 4. LRS

49. How many meaningful English words can be formed with the letters 'EGMA' using each letter exactly only once in each word?

1. 3 2. 2 3. 4 4. 1

50. Select the option that is related to the third word in the same way as the second word is related to the first word. (The words must be considered as meaningful English words and must not be related to each other based on the number of letters/number of consonants/vowels in the word.)

Red Cross : Hospital :: Wheel : ?

1. Progress 2. Tardiness
3. Danger 4. Family planning

General Awareness

51. In December 2022, who was sworn in as the new Chief Minister of Himachal Pradesh?

1. Mukesh Agnihotri
2. Sukhvinder Singh Sukhu
3. Jai Ram Thakur
4. Pratibha Singh

52. Padma Shri awardee Darshana Jhaveri is a famous _____ dancer.

1. Odissi 2. Sattriya
3. Mohiniyattam 4. Manipuri

53. Tanjore Balasaraswati was a dancer of which of the following dance forms?

1. Mohiniyattam 2. Kuchipudi
3. Kathak 4. Bharatanatyam

54. Which of the following states comes under the area of low rainfall?

1. Bihar 2. Gujarat 3. Tripura 4. Meghalaya

55. Aatmanirbhar Bharat Rojgar Yojana was implemented through which organisation?

1. India Post Payments Bank
2. HDFC Bank
3. Employees Provident Fund Organisation
4. Life Insurance Corporation

56. The Nehru Trophy Boat Race is held in _____.

1. Kerala 2. Goa
3. Maharashtra 4. Andhra Pradesh

57. Banabhatta was a court poet of Harshavardhana, who wrote a book called:

1. Mudrarakshasa 2. Arthashastra
3. Nitisara 4. Harshacharita

58. In which of the following years was the Goods and Services Tax (Compensation to States) Bill passed?

1. 2002 2. 2017 3. 2014 4. 2007

59. Which of the following Buddhist sages had initiated the Indo-Greek king Menander into Buddhism?

1. Sariputra 2. Asvaghosa
3. Nagasena 4. Vasubandhu

60. Who among the following is the author of the book 'Mrs Funny Bones'?

1. Soha Ali Khan 2. Divya Dutta
3. Twinkle Khanna 4. Tisca Chopra

61. When and where was the first Wimbledon tournament held?

1. 1877, Worple Road Site, Wimbledon
2. 1888, Church Road site, Wimbledon
3. 1887, Church Road site, Wimbledon
4. 1887, Worple Road Site, Wimbledon

62. The Rashtrakuta king who conquered the Cholas was:

1. Krishna III 2. Rajaraja I 3. Rajendra 4. Krishna I

63. In the context of a consumption function for an economy, if MPC = 0.6, then what is the likely value of MPS?

1. 0.4 2. 0.36 3. -0.6 4. 0.16

64. Match the columns:

State/UT	Monuments
(A) Maharashtra	(I) Jamali Qamali Mosque
(B) Delhi	(II) Hawa Mahal
(C) Rajasthan	(III) Laxmi Vilas Palace
(D) Gujarat	(IV) Elephanata Caves

1. A-IV, B-I, C-II, D-III 2. A-III, B-I, C-IV, D-II
3. A-I, B-II, C-III, D-IV 4. A-II, B-IV, C-III, D-I
65. Who among the following is the author of the book 'The House of Blue Mangoes'?
1. David Davidar 2. Durjoy Data
3. Arvind Adiga 4. Sekhar Bandyopadhyay
66. Who among the following had written the novel 'Untouchable'?
1. Harivansh Rai Bachchan 2. Raja Roy
3. Mulk Raj Anand 4. R K Narayan
67. Under Pradhan Mantri Fasal Bima Yojana, the maximum premium payable by the farmers will be _____ for horticulture crops.
1. 6% 2. 4% 3. 5% 4. 3%
68. Which of the following is a psychological disorder characterised by a refusal to eat food, caused by under-nutrition?
1. Marasmus 2. Kwashiorkor
3. Anorexia Nervosa 4. Bulimia Nervosa
69. Identify the element with an electronic configuration 2,8,1 from the following options.
1. Chlorine 2. Hydrogen
3. Magnesium 4. Sodium
70. The 'Aravalli' is the name of a _____ in India.
1. plateau 2. valley
3. mountain range 4. lake
71. Which of the following is the correct formula for calculating gross primary deficit?
1. Gross fiscal deficit – Net interest liabilities
2. Gross fiscal deficit + Net interest liabilities
3. Gross fiscal deficit – Borrowings from abroad
4. Gross fiscal deficit – Borrowing from RBI
72. Which of the following is NOT a constitutional body?
1. National Commission for Backward Classes
2. Election Commission of India
3. Reserve bank of India
4. Comptroller and Auditor-General of India
73. For which discovery in 1932 was James Chadwick best known?
1. Wave theory of light 2. Thermal ionisation
3. Neutron 4. Electron
74. Rubber is NOT a major cultivation of which of the following states of India?
1. Punjab 2. Meghalaya
3. Tamil Nadu 4. Kerala
75. Which of the following are satellite ports?
1. Chennai and Mumbai
2. Paradwip and Vishakhapatnam
3. Nhava Sheva and Haldia
4. Mormugao and New Mangalore port
76. Which of the following Government of India Acts of British India proposed the All India Federation (Federation of India)?
1. 1919 2. 1935 3. 1853 4. 1858
77. The most important and widely celebrated festival of Kerala is _____.
1. Onam 2. Nuakhai
3. Ugadi 4. Gudi Padwa
78. What happens to the motion of the particles as temperature rises?
1. The particles move in the same direction.
2. The particles slow down.
3. The particles move faster.
4. The particles stay stationary.
79. Which of the cell organelles includes RNA?
1. Cytoplasm 2. Ribosome 3. Cell base 4. Cell wall
80. Select the correct alternative on the given statements based on Ashoka's Lion capital and India's State Emblem.
- Statement I: In the original Ashoka's Lion Capital, there are four lions mounted back-to-back on a circular abacus that itself rests on a bell-shaped lotus.
- Statement II: The State Emblem is an adaptation of the Lion Capital of Asoka at Sarnath in which the bell-shaped lotus was omitted.
1. Only Statement II is true.
2. Both Statement I and Statement II are true.
3. Neither Statement I nor Statement II is true.
4. Only Statement I is true.
81. What is the trade strategy that India adopted in the first-seven Five-Year Plans?
1. Partially inward-looking trade strategy
2. Inward-looking trade strategy
3. Partially outward-looking trade strategy
4. Outward-looking trade strategy
82. The team of which state has won the Women's U-18 Hockey in Khelo India Youth Games 2022?
1. Haryana 2. Odisha
3. Jharkhand 4. Madhya Pradesh
83. With which of the following relief sculptures were the walls of the great Stupa of Amaravati in the Lower Godavari region adorned?
1. Sunken relief 2. Freestanding
3. Alto-relievo 4. Bas relief
84. Which of the following options represents the best choice for the Integrated Child Development Services (ICDS) Scheme?
1. Nutrition support 2. Travel support
3. Home Support 4. Clothing support
85. Who among the following politicians had written the autobiography 'My Country My Life'?
1. I K Gujral 2. Natwar Singh
3. L K Advani 4. Kapil Sibal
86. Which of the following is NOT a good conductor of electricity?
1. Gold 2. Sulphur 3. Silver 4. Aluminium
87. Which of the following processes occurs during decomposition in soil?
1. Crystallisation 2. Defragmentation
3. Humification 4. Oxidation
88. Pitt's India Act was passed in which of the following years?
1. 1782 2. 1784 3. 1781 4. 1780
89. Who among the following is a Carnatic music vocalist?
1. Ravi Shankar 2. Alla Rakha
3. M Balamuralikrishna 4. L Subramaniam
90. Match column A with column B.
- | Column A | Column B |
|----------------|-------------------------------------|
| a. Carnivores | i. Green plants |
| b. Producers | ii. Secondary or tertiary consumers |
| c. Decomposers | iii. Primary consumers |
| d. Herbivores | iv. Bacteria |
1. a-ii, b-i, c-iv, d-iii 2. a-iii, b-i, c-iv, d-ii
3. a-ii, b-iv, c-i, d-iii 4. a-iii, b-iv, c-i, d-ii
91. What was the estimated growth target of the Second Five-Year Plan in India?
1. 2.1% 2. 5.6% 3. 3.6% 4. 4.5%

92. India won which of the following medals in the 2022 Asia Cup hockey tournament?
1. None 2. Silver 3. Bronze 4. Gold
93. Six rights guaranteed by Article 19 can be suspended on the grounds of:
1. War 2. External aggression
3. Armed rebellion 4. Internal disturbance
1. 2, 3 and 4 only 2. 2 and 3 both
3. 4 only 4. 1 and 2 both
94. Under which Act did the individual members of the Executive Council have their own portfolio?
1. The Indian Councils Act of 1858
2. The Indian Councils Act of 1861
3. The Indian Councils Act of 1892
4. The Indian Councils Act of 1909
95. According to the census of India 2011, among the following which state has the highest sex ratio?
1. Uttar Pradesh 2. Rajasthan
3. Bihar 4. Andhra Pradesh
96. In which year did India host the Asian Games for the second time?
1. 1982 2. 1986 3. 1990 4. 1978
97. Tropical cyclones originate over which of the following regions?
1. Bay of Bengal, Arabian Sea and the Indian Ocean
2. Mediterranean Sea, Pacific Ocean and the Indian Ocean
3. Bay of Bengal, Arabian Sea and the Atlantic Ocean
4. Mediterranean Sea, Arabian Sea and the Indian Ocean
98. Bade Ghulam Ali Khan, a Hindustani classical vocalist, belonged to which of the following Gharanas?
1. Patiala 2. Kirana 3. Gwalior 4. Agra
99. The birth anniversary of Lord Jhulelal of the Sindhi community is also known as _____.
1. Jamshedi Navroj 2. Ulambana
3. Cheti Chand 4. Chaliho Sahib
100. Who used a home-made microscope to discover the invisible world of microbes, for which he is called the founding father of microbiology?
1. Antoni van Leeuwenhoek 2. Matthias Schleiden
3. Rudolf Virchow 4. Robert Brown
4. The solicitor ordered that we should solve the dispute over the land.
104. Given below are four jumbled sentences. Select the option that gives their correct logical sequence.
A. However, the most consumed tea in the world is Indian tea.
B. Tea was originated in China by its ruler, Shennong.
C. India also has the credit of being the world's largest producer.
D. This is because of the tropical and sub-tropical climate present here.
1. BACD 2. CBAD 3. DCAB 4. ABCD
105. Identify the most appropriate ANTONYM of the given word.
Reliable
1. Unknown 2. Untrustworthy
3. Uncommon 4. Unfamiliar
106. The given sentence is divided into four segments. Select the option that has the segment with a grammatical error.
He will / come when / he will be / ready.
1. he will be 2. come when
3. He will 4. ready.
107. Select the most appropriate meaning of the underlined idiom.
Our neighbour told my brother to keep an eye on their pet dog in their absence.
1. To ignore something or someone
2. To look after something or someone
3. To wait for something that is disturbing
4. To accomplish something too ambitious
108. Read the sentence carefully and select the most suitable idiom to fill in the blank.
Extreme inflation in the country has led to a hike in the price of day-to-day commodity. It has made it difficult to _____.
1. a blessing in disguise
2. break a leg
3. costs an arm and a leg
4. keep body and soul together
109. Identify the errors in the given sentence and choose the sentence that rectifies these errors.
My idea can be key idea for cracking difficult conflicts of extremely high level.
1. 1. My idea can be a key idea for cracking difficult conflicts of a extremely high level.
2. My idea can be key idea for cracking difficult conflicts of an extremely high level.
3. My idea can be an key idea for cracking difficult conflicts of an extremely high level.
4. My idea can be a key idea for cracking difficult conflicts of an extremely high level.

English Language and Comprehension

101. Select the most appropriate meaning of the underlined idiom in the given sentence.
He goes hard with one and all.
1. To be busy over trifles 2. To remain neutral
3. To be difficult 4. To be unreliable
102. Select the option that expresses the given sentence in passive form.
Who took Bruno for a walk?
1. With whom Bruno is taken for a walk?
2. By whom was Bruno taken for a walk?
3. By whom will Bruno be taken for a walk?
4. By whom has Bruno been taken for a walk?
103. Select the correct alternative from the given options that correctly changes the form of narration in the given sentence.
The solicitor said, "Let us solve the dispute over the land."
1. The solicitor wished that they should solve the dispute over the land.
2. The solicitor suggested that they might solve the dispute over the land.
3. The solicitor suggested that they should solve the dispute over the land.
110. Parts of the sentences are given below in jumbled order. Arrange the parts in the correct order to form a meaningful paragraph. The first part 'R.' is fixed.
R. Men usually make more decisions
A. and certainly the most important ones
B. earning a livelihood in most parts of the world
C. since men play a bigger role in
D. they have a major say in economic matters
1. ACDB 2. ACBD 3. DCAB 4. BADC
111. Select the most appropriate option to fill in the blank.
Technology has made it possible for us to reach out to more students, and it has also made it possible for us to deliver the same lessons in a much more _____ manner.
1. lumbering 2. resourceful
3. incompetent 4. encumbering

112. Select the option that expresses the given sentence in active voice.
The FIFA cup 2022 will be won by France.
1. France wins the FIFA cup 2022.
2. France would win the FIFA cup 2022.
3. France will win the FIFA cup 2022.
4. France will be winning the FIFA cup 2022.
113. The following sentence has been divided into parts. One of them may contain an error. Select the part that contains the error from the given options. If you don't find any error, mark 'No error' as your answer.
Vishnu and his friends / were listening to / the radio all morning.
1. No error
2. Vishnu and his friends
3. the radio all morning
4. were listening to
114. Identify the error in the given sentence and select the option that correctly rectifies the error.
PIEZO2 plays an critical role along with Piezo1 to regulate a important physiological process for brain to understand.
1. PIEZO2 plays an critical role along with Piezo1 to regulate the important physiological process for brain to understand.
2. PIEZO2 plays critical role along with Piezo1 to regulate a important physiological process for brain to understand.
3. PIEZO2 plays a critical role along with Piezo1 to regulate an important physiological process for the brain to understand.
4. PIEZO2 plays the critical role along with Piezo1 to regulate the important physiological process for brain to understand.
115. Select the most appropriate ANTONYM of the given word.
Admiration
1. Cognisance 2. Contempt 3. Accomplish 4. Diminish
116. Select the most appropriate option that can substitute the underlined segment in the given sentence.
Elegance and intelligence had the two most important traits of young ladies.
1. been the
2. has been the
3. are the
4. am being the
117. Select the most appropriate synonym of the given word.
Hind
1. Fore 2. Anterior 3. Ventral 4. Rear
118. Select the most appropriate ANTONYM of the underlined word.
Rukhsana was left alone in the house again, but fear was now her constant companion.
1. boring 2. steady 3. changing 4. friendly
119. Select the option that expresses the given sentence in direct speech.
She said she was seeing her brother the following day.
1. She said, "I am seeing my brother tomorrow."
2. She says, "I will see my brother tomorrow."
3. She said, "I was seeing my brother tomorrow."
4. She said, "I should see my brother tomorrow."
120. Select the option that expresses the given sentence in indirect speech.
The customer asked the tailor, "Will you have the dress ready by Tuesday?"
1. The customer asked the tailor if he should have the dress ready by Tuesday.
2. The customer asked the tailor if he would have the dress ready by Tuesday.
3. The customer asked the tailor if he will have the dress ready by Tuesday.
4. The customer asked the tailor if he would like to have the dress ready by Tuesday.
121. Identify the error in the given sentence and select the correct sentence from the given options.
The earth has a exceptional structure which may have helped in life's arrival.
1. An earth has exceptional structure which may have helped in life's arrival.
2. An earth has an exceptional structure which may have helped in life's arrival.
3. The earth has an exceptional structure which may have helped in life's arrival.
4. earth has exceptional structure which may have helped in life's arrival.
122. Parts of a sentence are given below in jumbled order. Select the option that arranges the parts in the correct sequence to form a meaningful sentence.
(P) the south pole of the Moon
(Q) and where no man has ever been before
(R) the Artemis mission will explore
(S) where ice has been confirmed to exist within craters
1. S, R, Q, P
2. Q, P, S, R
3. P, R, Q, S
4. R, P, S, Q
123. Parts of a sentence are given below in jumbled order. Select the option that arranges the parts in the correct sequence to form a meaningful sentence.
(P) showcasing objects of historic, scientific and cultural interest
(Q) by taking us back in time
(R) museums are always
(S) treasure troves of information
1. R, S, P, Q
2. Q, S, P, R
3. P, Q, S, R
4. S, P, R, Q
124. Select the option that expresses the given sentence in passive voice.
She is doing the homework.
1. The homework was done by her.
2. The homework was being done by her.
3. The homework has been done by her.
4. The homework is being done by her.
125. Select the option that expresses the given sentence in passive voice.
Malathi loves Reena.
1. Reena was loved by Malathi.
2. Reena is loved by Malathi.
3. Reena was being loved by Malathi.
4. Reena is being loved by Malathi.
126. Select the most appropriate idiom that can substitute the underlined segment in the given sentence.
Unless sales improve next month, the company will be in a critical position in which failure seems imminent.
1. a damp squib
2. hitting the sack
3. a mare's nest
4. up against the wall
127. Select the most appropriate option to fill in the blank.
Online shopping refers to purchasing goods available on the world wide web. You have different websites which have a huge _____ of products that you can choose from.
1. assessment
2. assortment
3. appraisal
4. assignment
128. Select the option that correctly expresses the given sentence in active voice.
The wounded woman was being helped by some youngsters.
1. Some youngsters have helped the wounded woman.
2. Some youngsters helped the wounded woman.
3. The woman found help by some youngsters.
4. Some youngsters were helping the wounded woman.

129. Select the most appropriate option to fill in the blank.
It is terrible that education systems all over the world are being held in captivity due to poverty, both at the governmental and family levels, despite the fact that education is claimed to be so important for human progress and the _____ of global economies.
1. revitalisation
 2. dismantling
 3. abrogation
 4. devastation
130. Select the option that expresses the given sentence in direct speech.
She asked me why I was not eating.
1. She said, "Why don't you eat?"
 2. She said, "Why am I not eating?"
 3. She said, "Why are you not eating?"
 4. She said, "Why is he not eating?"
131. Identify the errors in the given sentence and choose the sentence that rectifies these errors.
I have known her for many years. This time, she took unusual decision in unprejudiced way.
1. I have known her for many years. This time, she took an unusual decision in a unprejudiced way.
 2. I have known her for many years. This time, she took an unusual decision in an unprejudiced way.
 3. I have known her for many years. This time, she took a unusual decision in an unprejudiced way.
 4. I have known her for many years. This time, she took unusual decision in an unprejudiced way.
132. Which of the following sentences is in the past continuous tense?
1. They watched TV all evening.
 2. They would have watched TV all evening.
 3. They shall be watching TV all evening.
 4. They were watching TV all evening.
133. Select the option that expresses the given sentence in active voice.
Devotional songs are sung superbly by Sastri.
1. Sastri sings devotional songs superbly.
 2. Sastri is singing devotional songs superbly.
 3. Sastri has been singing devotional songs superbly.
 4. Sastri has superbly sung devotional songs.
134. Select the most appropriate option to fill in the blank.
I am _____ busy.
1. few
 2. quite
 3. tidily
 4. quiet
135. Select the option that expresses the given sentence in active voice.
A selected group of activists had been invited by the minister before the announcement of the strike.
1. The minister had been inviting a selected group of activists before the announcement of the strike.
 2. The minister had invited a selected group of activists before the announcement of the strike.
 3. The minister invited a selected group of activists before the announcement of the strike.
 4. The minister was inviting a selected group of activists before the announcement of the strike.
136. Select the option that expresses the given sentence in active voice.
I am not forced to study hard by my parents.
1. My parents did not force me to study hard.
 2. My parents will not force me to study hard.
 3. My parents do not force me to study hard.
 4. My parents are not forcing me to study hard.
137. Select the option that expresses the given sentence in reported speech.
Raju said to Reghu, "Stay back."
1. Raju ordered Reghu to stay back.
 2. Raju had ordered Reghu to stay back.
 3. Raju orders Reghu to stay back.
 4. Raju has ordered Reghu to stay back.
138. Select the option that expresses the given sentence in active voice.
Some students are known to grow wise early.
1. Some students have been knowing that they grow wise early.
 2. People know that some students grow wise early.
 3. Few of us know that students grow early.
 4. We all know that students grew wise early.
139. Select the option that expresses the given sentence in indirect speech.
She said, "I have finished my work."
1. She said that she had finished her work.
 2. She said that she would finish her work.
 3. She said that she will finish her work.
 4. She said that she has finished her work.
140. Parts of a sentence are given below in jumbled order. Arrange the parts in the correct order to form a meaningful sentence.
A: lost all his teeth
B: cannot eat hard food
C: he has
D: consequently, he
1. DACB
 2. ADBC
 3. BDAC
 4. CADB
141. Select the option that gives the most appropriate meaning of the underlined word.
Even amidst the all-pervasive silence, the noise inside her head seemed incessant.
1. To occur at irregular intervals or occasionally
 2. To continue without any interruption
 3. To impact in a strikingly negative way
 4. To follow an unknown course
142. Select the most appropriate ANTONYM of the word 'Concur' from the given sentence.
Every time they met, he found it difficult to resist her odd magic.
1. found
 2. difficult
 3. resist
 4. met
143. Parts of the following sentence have been given as options. Select the option that contains an error.
He will has been helping me with tending to my plants.
1. helping me
 2. to my plants
 3. He will has been
 4. with tending
144. Select the grammatically correct sentence from the options given.
1. A troll, a boy shared in on social media created an big laughter.
 2. The troll, a boy shared on an social media created a big laughter.
 3. An troll, the boy shared on the social media created the big laughter.
 4. The troll, the boy shared on social media created a big laughter.
145. Select the option that expresses the given sentence in indirect speech.
My friend said to me, "Do you know the recipe of mango ice-cream?"
1. My friend asked me that I knew the recipe of mango ice-cream.

2. My friend asked me if I know the recipe of mango ice-cream.
 3. My friend asked me if I knew the recipe of mango ice-cream.
 4. My friend asked me that I know the recipe of mango ice-cream.
146. Identify the meaning of the idiom used in the following sentence.
 I am feeling a bit under the weather.
 1. feeling angry 2. feeling energetic
 3. feeling slightly ill 4. feeling lazy and bored
147. Select the most appropriate ANTONYM of the given word.
 Admonish
 1. Abetment 2. Applaud 3. Abide 4. Accede
148. The following sentence has been split into four segments. Identify the segment that contains a grammatical error.
 That accident happened [A] /a long time ago, but [B] / I have shivered at [C] / the thought of it ever for [D].
 1. D 2. C 3. A 4. B
149. Select the most appropriate ANTONYM of the word given in the bracket to fill in the blank.
 The development of the region also depended on the _____ (rapaciousness) of the corporate contribution via a social responsibility scheme.
 1. generosity 2. voracity 3. greed 4. violence
150. Select the option that expresses the given sentence in indirect speech.
 "I am playing the keyboard," she explained.
 1. She explained that she is playing the keyboard.
 2. She said that she had been playing the keyboard.
 3. She said that she is playing the keyboard.
 4. She explained that she was playing the keyboard.
151. Select the option that gives the most appropriate meaning of the underlined word.
 The patient absconded from the hospital at dawn.
 1. Fled away hurriedly and secretly
 2. Collected acknowledgement of the payment
 3. Faced lack of cooperation from the nurse
 4. Learned to communicate with others
152. Select the option that expresses the given sentence in indirect speech.
 She said to me, "I shall come to meet you tomorrow."
 1. She asked me that could she come to meet me the next day.
 2. She tells me that she could come to meet me tomorrow.
 3. She told me that she will come to meet me tomorrow.
 4. She told me that she would come to meet me the next day.
153. Select the option that expresses the given sentence in passive voice.
 It is time to have tea.
 1. Tea is to be taken by it.
 2. Tea is to be had.
 3. Time must be taken to prepare tea.
 4. It is time for tea to be had.
154. Select the option that expresses the following sentence in active voice.
 The cake was baked by the chef in the kitchen.
 1. The chef baked the cake in the kitchen.
 2. The kitchen was baking the cake by the chef.
 3. The cake is being baked by the chef in the kitchen.
 4. The cake was being baked by the chef in the kitchen.
155. Select the most appropriate option to fill in the blank.
 They could not reach the railway station before the train _____.
 1. has been leaving 2. leave
 3. has leave 4. left
156. Select the option that expresses the given sentence in active voice.
 Parents should be respected by their children.
 1. Children are to respect their parents.
 2. Children shall be respecting their parents.
 3. Children should respect their parents.
 4. Children should be respecting their parents.
157. Sentences of a paragraph are given below in jumbled order. Arrange the sentences in the correct order to form a meaningful and coherent paragraph.
 P. Applied arts require an object to be functional, as well as beautiful.
 Q. They recognised that their work belonged to the higher social classes who had the wealth to purchase art and the leisure time to enjoy it.
 R. Fine art is categorised as something which only has an aesthetic or conceptual function.
 S. There are a number of different categories of objects and processes under the umbrella term of art which need to be explored.
 T. In the twentieth century, artists began to challenge the established notion of art.
 U. Art is typically divided into two areas: fine art (such as painting, sculpture, music and poetry) and the applied arts (such as pottery, weaving, metal working, furniture making and calligraphy).
 1. RPSTUQ 2. SURPTQ
 3. SUPQRT 4. SRPUTQ
158. Select the most appropriate option that can substitute the underlined segment in the given sentence.
 The patient couldn't survive the injuries and succumbed with death.
 1. succumbed to death 2. succumbed by death
 3. succumbed into death 4. succumbed in death
159. Select the option that expresses the given sentence in direct speech.
 She said that she could bake cookies.
 1. She had said, "I can bake cookies."
 2. She said, "I can bake cookies."
 3. She says, "I can bake cookies."
 4. She said, "I may bake cookies."
160. Select the option that expresses the following sentence in direct speech.
 They said that they had been waiting for the bus for over an hour.
 1. "We have been waiting for the bus for over an hour," they said.
 2. "We waited for the bus for over an hour," they said.
 3. "We had waited for the bus for over an hour," they said.
 4. "We are waiting for the bus for over an hour," they said.
161. Select the most appropriate adverb to fill in the blank.
 Over and _____ being hardworking, he is thoroughly honest.
 1. above 2. over 3. again 4. ever
162. Select the most appropriate ANTONYM of the given word.
 Amplify
 1. Exaggerate 2. Lessen 3. Dislike 4. Enrich
163. Select the option that expresses the given sentence in indirect speech.
 He said, "I have finished my homework."
 1. He said that he had to finish his homework.
 2. He said that he has finished his homework.
 3. He said that he would finish his homework.
 4. He said that he had finished his homework.

164. Select the option that will improve the underlined part of the given sentence.

He was the most cleverest man I ever knew.

1. cleverest 2. most cleverer
3. more clever 4. cleverer

165. Choose the most appropriate meaning of the given idiom.

To get wind of

1. To get into difficulty
2. To recover from something
3. To escape so that you don't have to pay
4. To hear a piece of information that someone was trying to keep secret

166. The following sentence has been split into four segments. Identify the segment that contains a grammatical error.

You have said that, / as he took money from you many times, / he owes you / five thousand rupees all together.

1. he owes you
2. five thousand rupees all together
3. You have said that,
4. as he took money from you many times,

167. Select the most appropriate synonym of the given word.

Vanquish

1. Quantify 2. Conquer 3. Describe 4. Verify

168. Select the most appropriate ANTONYM of the underlined word in the given sentence.

The amateur proved them all wrong.

1. Assistant 2. Prefect 3. Chef 4. Professional

169. Select the most appropriate synonym of the given word.

Ignoramus

1. Stupid 2. Cautious 3. Playful 4. Deceitful

170. Parts of the following sentence have been given as options. Select the option that contains an error.

It became a known fact that they most played techno music at every party.

1. every 2. at 3. that 4. most

Comprehension:

In the following passage, some words have been deleted. Read the passage carefully and select the most appropriate option to fill in each blank.

Earthquakes represent a highly consequential and perilous category of (1)_____disasters. These phenomena arise as a result of several variables and result in subsequent consequences. An earthquake refers to the abrupt release of accumulated strain (2)_____ within the Earth's crust, leading to seismic shaking that propagates out ward from the (3)_____. In essence, seismic activity refers to the abrupt displacement of theEarth's surface, commonly referred to as an earthquake, tremor or temblor. Earthquakes exhibit a range of magnitudes, encompassing both imperceptible tremors and catastrophic events capable of causing (4)_____ urban devastation. Seismicity refers to the occurrence, magnitude and classification of earthquakes. Earthquakes can also arise as a (5)_____ of volcanic activity. Moreover, these phenomena have diverse impacts that disrupt both individuals' livelihoods and physical assets.

171. Select the most appropriate option to fill in blank number 1.

1. unrealistic 2. artificial 3. natural 4. unnatural

172. Select the most appropriate option to fill in blank number 2.

1. light 2. energy 3. mineral 4. metal

173. Select the most appropriate option to fill in blank number 3.

1. middleman 2. paradoxical 3. opened 4. epicentre

174. Select the most appropriate option to fill in blank number 4.

1. limited 2. small
3. extensive 4. minimal

175. Select the most appropriate option to fill in blank number 5.

1. consequence 2. classification
3. name 4. direction

Comprehension:

In the following passage some words have been deleted. Read the passage carefully and select the most appropriate option to fill in each blank.

Frogs are the amphibians. It indicates that they are (1)_____ of living both in water and on land. Frogs have long back legs that propel them into the air, making them excellent jumpers. A large portion of them have suckers on their fingers, which assist them with landing securely on tricky surfaces. They find quick bugs, with the (2)_____ of their long tacky tongues. Frogs do not all contain poison. When threatened by predators, some frogs use a venom that they have developed. The golden dart frog is the world's most lethal frog. One frog's skin has the potential to kill up to 1,000 people.

The normal frog contains a toxic substance, which it (3)_____ from its skin, when gone after. This poison affects both canines and felines. However, they rarely experience serious (4)_____. Cane toads are extremely large toads that are laced with drugs. If taken, these drugs can result in hallucinations. Central and South America are home to poison dart frogs. Because indigenous people use their toxic excretions to (5)_____ the tips of arrows and blow darts, the frogs are frequently referred to as poison arrow frogs or poison dart frogs.

176. Select the most appropriate option to fill in blank number 1.

1. susceptible 2. dispose 3. capable 4. incline

177. Select the most appropriate option to fill in blank number 2.

1. encouragement 2. assistance
3. backing 4. excuse

178. Select the most appropriate option to fill in blank number 3.

1. spells 2. radiates 3. glows 4. squeaks

179. Select the most appropriate option to fill in blank number 4.

1. sequels 2. consequences
3. disturbs 4. alters

180. Select the most appropriate option to fill in blank number 5.

1. bane 2. hate 3. poison 4. malice

Comprehension:

In the following passage, some words have been deleted. Read the passage carefully and select the most appropriate option to fill in each blank.

For most of us who are born and live in India, social inequality and (1)_____ are facts of life. We see (2)_____ on the streets and on railway platforms. We see young children (3)_____ as domestic workers, construction helpers, cleaners and helpers in streetside restaurants (dhabas) and tea-shops. We are not (4)_____ at the sight of small children, who work as domestic workers in middle class urban homes, carrying the school bags of older children to school. It does not immediately (5)_____ us as unjust that some children are denied schooling.

181. Select the most appropriate option to fill in blank number 1.

1. exclusion 2. gatherings
3. mobility 4. harmony

182. Select the most appropriate option to fill in blank number 2.

1. vehicles 2. airports 3. beggars 4. parliaments

183. Select the most appropriate option to fill in blank number 3.

1. excelling 2. revolting 3. labouring 4. cheating

184. Select the most appropriate option to fill in blank number 4.

1. envious 2. composed 3. surprised 4. afraid

185. Select the most appropriate option to fill in blank number 5.

1. strike 2. force 3. touch 4. slap

Comprehension:

In the following passage, some words have been deleted. Read the passage carefully and select the most appropriate option to fill in each blank.

Research on infections over the past few decades has focused on hospitals, day-care facilities and schools, but (1)_____ attention was paid to the home. Today, the increase of foodborne illness and a (2)_____ need for home health care have focused interest on hygiene and cleanliness in the home. 'Hygiene' refers to conditions or practices by which people maintain or promote good health by keeping themselves and their surroundings (3)_____. Even in our contemporary society, good hygiene practices continue to be the primary disease-prevention strategy. Hygiene is one of the silent victories of public health. Personal hygiene and household cleanliness practices affect the risk (4)_____ spreading infectious disease. There are many disease-causing microbes whose transmission can be controlled by proper personal hygiene and household cleaning practices. A framework for developing practical home strategies to manage risk from infections is (5)_____.

186. Select the most appropriate option to fill in blank no. 1.

1. no little 2. a little 3. the little 4. little

187. Select the most appropriate option to fill in blank no. 2.

1. rare 2. decreasing 3. growing 4. declining

188. Select the most appropriate option to fill in blank no. 3.

1. cluttered 2. close 3. clear 4. clean

189. Select the most appropriate option to fill in blank no. 4.

1. of 2. for 3. about 4. at

190. Select the most appropriate option to fill in blank no. 5.

1. risky 2. required 3. ineffective 4. impossible

Comprehension:

Read the given passage carefully and answer the questions that follow.

Financial literacy is the ability to understand and effectively use financial skills. These financial skills are as simple as budgeting, investing, credit management and financial management. In other words, financial literacy is the ability to manage money. A strong foundation of these financial skills will help in achieving various life goals like retirement, education and even going on a vacation.

Financial literacy includes many skills. However, the most popular ones are budgeting, managing expenses, paying off debt and understanding the risk-return trade-off in investment products. Acquiring these skills would require one to understand the basic financial concepts like time value of money, compound interest, annualised return and opportunity cost.

With an abundance of credit products available in the market, like credit card debt, overdraft facility on debit cards and EMI, financial literacy becomes important. Understanding debt and having basic financial knowledge will help individuals to use these products responsibly.

Financial literacy often teaches individuals how to make major financial decisions. Moreover, it increases financial discipline and financial capability. This will lead to major lifestyle changes like saving and investing regularly, managing debts effectively and fulfilling life goals efficiently. Additionally, financial literacy will ensure one's financial wellbeing and also protect individuals from financial frauds.

Lacking the knowledge of these skills leads to financial illiteracy. Financial illiteracy leads to budget mismatch, higher expenses than income, accumulation of debts, poor credit score, being victims to financial frauds and other negative consequences.

Financial literacy is important because it equips one with the knowledge and skill to manage money effectively. Without financial literacy, the actions and decisions one makes or do not make with respect to savings and investments would lack a strong foundation.

Financial literacy helps in understanding financial concepts better and enables one to manage their finances efficiently. Furthermore, it helps in effective money management, making financial decisions, and achieving financial stability. Moreover, financial literacy provides in-depth knowledge of financial education and various strategies that are indispensable for financial growth and success. Also, it enables one to be debt free by adopting the best debt strategies.

191. Select the most appropriate ANTONYM of the given word with reference to its usage in the passage.

Stability

1. Steadiness 2. Ambiguity 3. Volatility 4. Inefficacy

192. Which of the following is NOT a result of financial illiteracy?

1. Financial discipline 2. Accumulation of debts
3. Budget mismatch 4. Higher expense than income

193. Which of the following statements would the author of the above passage agree to?

1. Financial literacy cannot help in budgeting and paying off the debts.
2. Effective money management skills enable early retirement.
3. Financial literacy is important only for those who are materialistic.
4. Important life goals and ambitions are not typically related to financial skills.

194. Identify the tone of the passage.

1. Subjective 2. Satirical
3. Informative 4. Critical

195. Select the most appropriate title for the passage.

1. Why is Financial Illiteracy Important
2. Tips for Financial Growth
3. The Importance of Financial Literacy
4. Making Financial Decisions

Comprehension:

Read the given passage carefully and answer the questions that follow.

Scarlett O'Hara famously asked her husband, Rhett Butler, "Where shall I go?" to which he famously replied, "Frankly, my dear, I don't give a damn." One of the finest movie quotations ever is found toward the end of director Victor Fleming's 1939 American historical romantic epic film, *Gone with the Wind*, it's also one of all-time favourite lines from a movie. But in 1930s American society, the term 'damn' was a swear word. Due to the word's offensive nature and consequent prohibition by the 1930 Motion Picture Production Code, sometimes known as the 'Hays Code', American film censors insisted on its removal two months prior to the movie's release. A few weeks before the movie's release, the Motion Picture Association of America board amended the Production Code, which caused the censors to change their minds.

A word that had originally been offensive became suddenly unoffensive, most likely as a result of the changed sensitivities of American culture that made it possible to update the Motion Picture Production Code. Since then, American perceptions of these issues have advanced significantly.

What is offensive to society will continue to be offensive unless its sensibilities significantly shift. People's senses, belief systems, conventions and practices don't change suddenly. They develop slowly. Therefore, it is meaningless to inquire as to why something should be offensive to some while not being so to others, or why people aren't saner and more tolerant when it comes to sensitive and disputed social topics.

Cinema has a significant impact on its consumers since it is a captivating audio-visual medium of entertainment that teaches information, knowledge, beliefs, values, etc. A film's effects on

people and society can be either beneficial or bad depending on its subject matter and method of presentation. While a movie may be suitable for certain people's age and sensibilities, it may not be suitable for other people's age and sensibilities. Not everyone is intended to watch every movie. A controversial movie might also spark societal turmoil or even violence. As a result, every nation requires a formal agency to oversee its cinema ethics and policy. In India, the Central Board of Film Certification (CBFC), sometimes known as the 'Censor Board', must certify a movie as appropriate for the purpose before it can be released for public screening.

Under the Cinematograph Act of 1952, the CBFC, which operates as a statutory agency under the Ministry of Information and Broadcasting, controls how movies are shown. Its responsibility is to make sure that the nation's citizens enjoy wholesome enjoyment through cinematic media. The CBFC is required to certify that a movie, in whole or in part, does not jeopardise India's sovereignty and integrity, jeopardise its security and relations with foreign states, cause public disorder or crime, cause defamation or court contempt, violate social norms and values, offend any group of people or community, etc.

196. Identify the structure of the passage.

- | | |
|-------------------|-------------------------|
| 1. Classification | 2. Sequential |
| 3. Descriptive | 4. Compare and contrast |

197. Why/how did the word, which had originally been offensive, become unoffensive suddenly?

1. Because of changed sensitivity of American culture
2. Because of people's age and norms
3. Because of the control by the Censor Board
4. Because of the conventions

198. Which of the following words was interpreted as offensive in American Society in the 1930s?

- | | |
|----------------|-------------|
| 1. Meaningless | 2. Damn |
| 3. Code | 4. Disputed |

199. Why does CBFC have to certify and control the content shown in a movie?

1. To cause public disorder or crime
2. To not jeopardise India's sovereignty and integrity
3. To jeopardise India's security
4. To violate social norms

200. What is the passage based upon?

1. Motion picture production code
2. Trending movies
3. Impact of cinema on people's sensibilities
4. Action epic film

Answer Key

1. (2)	2. (3)	3. (2)	4. (4)	5. (4)	6. (4)	7. (2)	8. (3)	9. (4)	10. (3)
11. (2)	12. (3)	13. (1)	14. (4)	15. (1)	16. (4)	17. (3)	18. (4)	19. (1)	20. (3)
21. (4)	22. (1)	23. (4)	24. (3)	25. (2)	26. (1)	27. (2)	28. (4)	29. (2)	30. (4)
31. (4)	32. (1)	33. (1)	34. (3)	35. (4)	36. (1)	37. (2)	38. (3)	39. (4)	40. (4)
41. (3)	42. (3)	43. (1)	44. (3)	45. (1)	46. (4)	47. (1)	48. (3)	49. (1)	50. (1)
51. (2)	52. (4)	53. (4)	54. (2)	55. (3)	56. (1)	57. (4)	58. (2)	59. (3)	60. (3)
61. (1)	62. (1)	63. (1)	64. (1)	65. (1)	66. (3)	67. (3)	68. (3)	69. (4)	70. (3)
71. (1)	72. (3)	73. (3)	74. (1)	75. (3)	76. (2)	77. (1)	78. (3)	79. (2)	80. (2)
81. (2)	82. (1)	83. (4)	84. (1)	85. (3)	86. (2)	87. (3)	88. (2)	89. (3)	90. (1)
91. (4)	92. (3)	93. (4)	94. (2)	95. (4)	96. (1)	97. (1)	98. (1)	99. (3)	100. (1)
101. (3)	102. (2)	103. (3)	104. (1)	105. (2)	106. (1)	107. (2)	108. (4)	109. (4)	110. (2)
111. (2)	112. (3)	113. (1)	114. (3)	115. (2)	116. (3)	117. (4)	118. (3)	119. (1)	120. (2)
121. (3)	122. (4)	123. (1)	124. (4)	125. (2)	126. (4)	127. (2)	128. (4)	129. (1)	130. (3)
131. (2)	132. (4)	133. (1)	134. (2)	135. (2)	136. (3)	137. (1)	138. (2)	139. (1)	140. (4)
141. (2)	142. (3)	143. (3)	144. (4)	145. (3)	146. (3)	147. (2)	148. (1)	149. (1)	150. (4)
151. (1)	152. (4)	153. (4)	154. (1)	155. (4)	156. (3)	157. (2)	158. (1)	159. (2)	160. (1)
161. (1)	162. (2)	163. (4)	164. (1)	165. (4)	166. (2)	167. (2)	168. (4)	169. (1)	170. (4)
171. (3)	172. (2)	173. (4)	174. (3)	175. (1)	176. (3)	177. (2)	178. (2)	179. (2)	180. (3)
181. (1)	182. (3)	183. (3)	184. (3)	185. (1)	186. (4)	187. (3)	188. (4)	189. (1)	190. (2)
191. (3)	192. (1)	193. (2)	194. (3)	195. (3)	196. (3)	197. (1)	198. (2)	199. (2)	200. (3)

Answers with Explanations

1. **Option (2) is correct.**

$$9 \times 9 + 2 = 83, 83 \times 2 - 2 = 164$$

$$4 \times 4 + 2 = 18, 18 \times 2 - 2 = 34$$

$$\therefore 6 \times 6 + 2 = 38, 38 \times 2 - 2 = 74$$

2. **Option (3) is correct.**

Hence, Conclusion I and II follow.

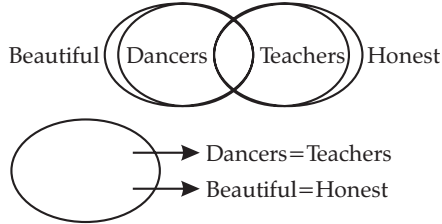

3. **Option (2) is correct.**

2, 7, 11 → All prime
13, 17, 29 → All prime
13, 17, 23 → All prime

4. **Option (4) is correct.**

$$12^2 + 24 = 168, 11^2 + 24 = 145$$

$$8^2 + 24 = 88$$

5. **Option (4) is correct.**

By interchanging + and ÷ and 2 and 18,
 $18 - 55 \div 11 \times 4 + 2$
 $= 18 - 5 \times 4 + 2 = 18 - 20 + 2 = 0$

6. **Option (4) is correct.**

$$5 \times 3 - 1 = 14; 14 \times 3 - 1 = 41;$$

$$41 \times 3 - 1 = 122; 122 \times 3 - 1 = 365;$$

$$365 \times 3 - 1 = 1094$$

7. **Option (2) is correct.**

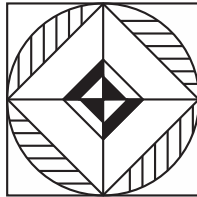

8. **Option (3) is correct.**

Figure Z is embedded in 3 only

9. **Option (4) is correct.**

The person sitting immediately right to Z is B.

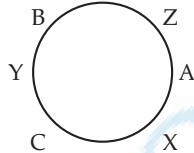

10. **Option (3) is correct.**

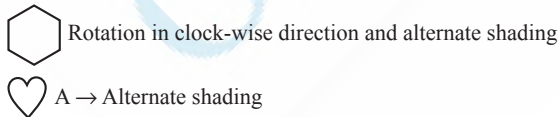

11. **Option (2) is correct.**

$\therefore M > O$ and $X \geq O$
then It can not be concluded that $M > X$
 $\therefore Y < O \leq W$
 $\therefore Y < W$
So, Conclusion II is true.

12. **Option (3) is correct.**

$$\therefore + \text{ interchanged with } - \text{ and } \times \text{ interchanged with } \div$$

$$\therefore 108 \div 2 + 14 \times 6 - 27$$

$$= 54 + 84 - 27 = 54 + 57 = 111$$

13. **Option (1) is correct.**

There are 8 parallelogram.

14. **Option (4) is correct.**

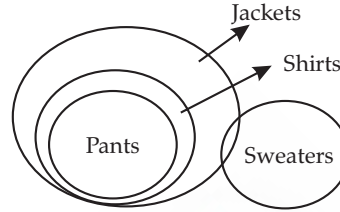

15. **Option (1) is correct.**

$$I \quad G \quad K \quad L \quad J \quad N \quad O \quad M \quad Q \quad R \quad P \quad T \quad U \quad S \quad W$$

$$-2 \quad +4 \quad +1 \quad -2 \quad +4 \quad +1 \quad -2 \quad +4 \quad +1 \quad -2 \quad +4 \quad +1 \quad -2 \quad +4$$

16. **Option (4) is correct.**

$$5 + 0 + 5 = 10; 6 + 0 + 4 = 10; 2 + 1 + 7 = 10$$

$$\therefore 2 + 4 + 4 = 10; 2 + 2 + 6 = 10; 2 + 6 + 2 = 10$$

17. **Option (3) is correct.**

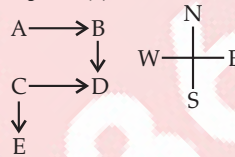

\therefore A is to the North of E.

18. **Option (4) is correct.**

+ interchange with \times
- interchange with \div

$$5 \times 3 + 2 - 10 \div 5$$

$$= 15 + 2 - 2 = 15$$

19. **Option (1) is correct.**

3 interchanges with 9
and - interchanges with \times .
option 1 : $12 \div 3 \times 2 - 7 + 9$
 $\Rightarrow 4 \times 2 - 7 + 9 = 8 - 7 + 9 = 10$

20. **Option (3) is correct.**

$$WGDE \quad ZEGC \quad CCJA \quad FAMY \quad IYPW$$

$$\begin{matrix} -2 & -2 & -2 & -2 \\ \text{---} & \text{---} & \text{---} & \text{---} \end{matrix}$$

21. **Option (4) is correct.**

$$\begin{matrix} +2 & -5 \\ \text{---} & \text{---} \\ D & F & A \end{matrix} \quad \begin{matrix} +2 & -5 \\ \text{---} & \text{---} \\ P & R & M \end{matrix}$$

$$\begin{matrix} +2 & -5 \\ \text{---} & \text{---} \\ I & K & F \end{matrix} \quad \begin{matrix} +2 & -4 \\ \text{---} & \text{---} \\ S & U & Q \end{matrix}$$

22. **Option (1) is correct.**

Hence, neither Conclusion I nor II follows.

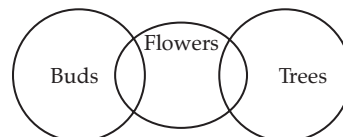

23. Option (4) is correct.

$$\begin{aligned} \times \rightarrow \div; \div \rightarrow - \\ - \rightarrow +; + \rightarrow \times \\ \therefore 7 \times 5 - 3 + 12 \div 4 \\ \Rightarrow 35 - 3 + 3 = 35 \end{aligned}$$

24. Option (3) is correct.

$$\begin{aligned} 122 + 13 = 135, 135 + 26 = 161, \\ 161 + 39 = 200; 200 + 52 = 252, \\ 252 + 65 = 317 \end{aligned}$$

25. Option (2) is correct.

$$\begin{aligned} 12 + 2^2 = 16, 16 + 3^2 = 25, 25 + 5^2 = 50, \\ 50 + 7^2 = 99, 99 + 11^2 = 220, 220 + 13^2 = 389 \end{aligned}$$

26. Option (1) is correct.

Only option (1) is present in figure

27. Option (2) is correct.

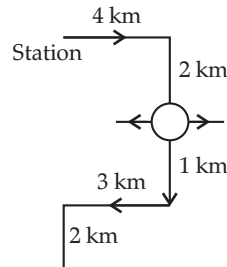

After taking second left from the roundabout to reach his home, he travelled $1 + 3 + 2 = 6$ km.

28. Option (4) is correct.

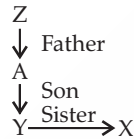

So, Z is grandfather of X.

29. Option (2) is correct.

CALENDAR METHOD:

Day Code:

Sun	Mon	Tue	Wed	Thu	Fri
0	1	2	3	4	5

MONTH CODE:

Month	Jan	Feb	Mar	Apr	May	Jun	Jul	Aug	Sep	Oct	Nov	Dec
Normal	0	3	3	6	1	4	6	2	5	0	3	5
Leap Year	6	2	3	6	1	4	6	2	5	0	3	5

Century Code:

1600	1700	1800	1900	2000	2100	2200	2300
6	4	2	0	6	4	2	0

Note: Multiple of 400 year code will be 6 and next year code Should be 4,2,0, respectively and so on.

$$\text{Date} = 14$$

$$\text{Code for Sept} = 5$$

$$\text{Code for century} = 2$$

$$3041 = 3000 + 41 \text{ (and } 41/4 = 10)$$

$$\text{Adding all these} = 14 + 5 + 2 + 41 + 10 = 72,$$

$$\frac{72}{7} = 2 \text{ (Tuesday)}$$

30. Option (4) is correct.

$$\begin{aligned} 14^2 + 4 = 200 \\ 5^2 + 4 = 29 \\ 16^2 + 4 = 260 \end{aligned}$$

31. Option (4) is correct.

$$\begin{aligned} \text{BOOK} &= (2 + 15 + 15 + 11) \times 4 = 172 \\ \text{PAGES} &= (16 + 1 + 7 + 5 + 19) \times 5 = 240 \\ \text{LIBRARY} &= (12 + 9 + 2 + 18 + 1 + 18 + 25) \times 7 = 595 \end{aligned}$$

32. Option (1) is correct.

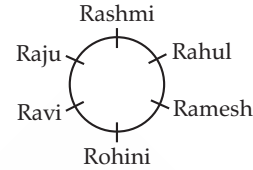

\therefore Rashmi is sitting immediately to the left of Raju.

33. Option (1) is correct.

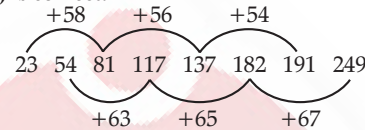

34. Option (3) is correct.

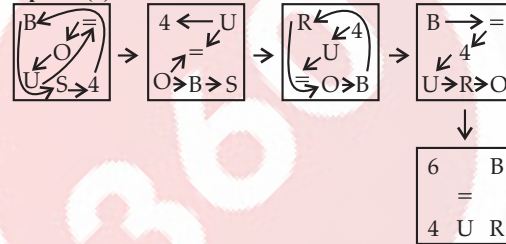

35. Option (4) is correct.

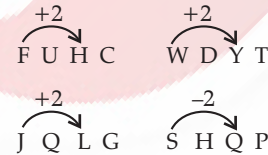

36. Option (1) is correct.

$$\begin{aligned} (4 + 1)^3 = 125, (8 + 1)^3 = 729 \\ (11 + 1)^3 = 1728 \end{aligned}$$

37. Option (2) is correct.

PRICE $16 + 18 + 9 + 3 + 5 = 51$ $\Rightarrow 61 - 51 = 10$	EGRTK $5 + 7 + 18 + 20 + 11 = 61$
STAGE $19 + 20 + 1 + 7 + 5 = 52$ $\Rightarrow 62 - 52 = 10$	IGUVC $9 + 7 + 21 + 22 + 3 = 62$
RIGHT $18 + 9 + 7 + 8 + 20 = 62$ $\Rightarrow 72 - 62 = 10$	JVTKI $10 + 22 + 20 + 11 + 9 = 72$

38. Option (3) is correct.

$$\begin{aligned} (16 + 1) \times 5 = 85, (23 + 1) \times 5 = 120 \\ (28 + 1) \times 5 = 145 \end{aligned}$$

39. Option (4) is correct.

$$\begin{aligned} L \rightarrow \div, N \rightarrow \times, P \rightarrow +, J \rightarrow - \\ 19 L 95 N 5 J 35 P 7 \\ \text{Replace N and L} \\ 19 N 95 L 5 J 35 P 7 \\ = 19 \times 95 \div 5 - 35 + 7 \\ = 19 \times 19 - 35 + 7 \\ = 361 - 35 + 7 = 333 \end{aligned}$$

40. Option (4) is correct.

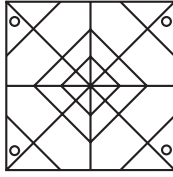

41. Option (3) is correct.

Possible order oldest to youngest is

F H M N K L G

30 20 12

Youngest + second oldest = 42

$H + 12 = 42 \Rightarrow H = 30$

But if age of K is multiple 10 and less than 30 then age of K is 20.

Therefore the possible age of L is 15 years.

42. Option (3) is correct.

17 18 22 31 47 72 108 157
 1 4 9 16 25 36 49

43. Option (1) is correct.

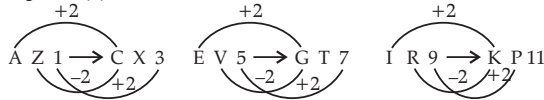

44. Option (3) is correct.

Mother

A⁻ = F⁺

| |

C⁻ B⁺

| |

E⁻ D⁺

Where + sign is used for male and - is used for female.

45. Option (1) is correct.

Correct order as English dictionary is d, a, e, c, b.

46. Option (4) is correct.

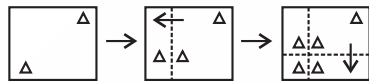

So, D is correct figure.

47. Option (1) is correct.

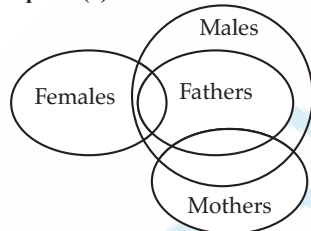

48. Option (3) is correct.

$\begin{matrix} -3 & -3 & & -3 & -3 & & -3 & -3 \\ G & D & A & O & L & I & W & T & Q \\ -3 & -3 & & -3 & -3 & & & & \\ E & B & Y & M & J & G & & & \end{matrix}$

49. Option (1) is correct.

Three meaningful words with letter EGMA are GAME, MEGA, MAGE.

50. Option (1) is correct.

The relationship between the Red Cross and Hospital is that the Red Cross is a symbol commonly associated with hospitals and medical aid. Similarly, a Wheel is a symbol associated with Progress, as it represents movement and advancement.

51. Option (2) is correct.

Sukhvinder Singh Sukhu was sworn in as the Chief Minister of Himachal Pradesh on 11 December 2022, following the Congress party's victory in the state elections. Sukhu, a senior Congress leader, replaced Jai Ram Thakur, the outgoing Chief Minister of the Bharatiya Janata Party (BJP). His leadership marked the return of the Congress to power in the state after a gap of five years.

52. Option (4) is correct.

Darshana Jhaveri is a renowned Manipuri dancer. She was awarded the Padma Shri in 2007 for her exceptional contribution to the field of Manipuri dance, a classical dance form from the northeastern state of Manipur. Her work has helped in promoting and preserving the rich cultural heritage of Manipuri dance.

53. Option (4) is correct.

Tanjore Balasaraswati was a renowned dancer of Bharatanatyam. She is considered one of the greatest exponents of this classical dance form, and her contributions significantly elevated its status in India and abroad. Balasaraswati was known for her deep expression, technical mastery and commitment to the traditional aspects of Bharatanatyam.

54. Option (2) is correct.

The state that falls under the area of low rainfall is Gujarat. Gujarat is known for its dry climate, particularly in the Kutch region and the western part of the state. While parts of Gujarat, like the Saurashtra region, receive moderate rainfall, the overall state experiences relatively low rainfall compared to other regions in India, such as Meghalaya or Bihar, which receive higher rainfall due to their geographical features.

55. Option (3) is correct.

The Aatmanirbhar Bharat Rojgar Yojana was implemented through the Employees Provident Fund Organisation (EPFO). This scheme was launched by the Government of India in 2020 to encourage job creation and protect existing jobs during the COVID-19 pandemic. It aimed to provide financial assistance to employers and employees by contributing to the EPF accounts of new employees and those who had lost their jobs.

56. Option (1) is correct.

The Nehru Trophy Boat Race is held in Kerala. It is one of the most famous and popular boat races in India, held annually on the Punnappra-Vayalar backwaters of Alappuzha (Alleppey) in Kerala. The race is named after Jawaharlal Nehru, the first Prime Minister of India, who visited the area in 1952 and was so impressed by the event that he donated a trophy for the competition.

57. Option (4) is correct.

Banabhatta was a court poet of King Harshavardhana, and he wrote the book *Harshacharita*. It is a Sanskrit word that details the life and achievements of Harshavardhana, who ruled North India during the 7th century. The text is an important historical source that provides insight into the political and cultural landscape of the time.

58. Option (2) is correct.

The Goods and Services Tax (Compensation to States) Bill was passed in 2017. This bill was part of the implementation process for the GST in India, which was introduced to create a unified tax structure across the country. The Bill provided compensation to states for any revenue loss due to the introduction of GST.

59. Option (3) is correct.

The Buddhist sage who initiated the Indo-Greek king Menander into Buddhism was Nagasena. Nagasena is a prominent figure in the *Milinda Panha* (The Questions of King Milinda), a Buddhist text that records the dialogues between King Menander (also known as Milinda) and the sage Nagasena. This text is a key source in understanding early Buddhist philosophy and logic.

60. Option (3) is correct.

The author of the book '*Mrs Funny Bones*' is Twinkle Khanna. Twinkle Khanna, a former Bollywood actress, turned author with this humorous book, which became a bestseller. The book reflects her thoughts on everyday life, marriage and parenting in a light-hearted manner.

61. Option (1) is correct.

The first Wimbledon tournament was held in 1877, at Worple Road Site, Wimbledon. This inaugural tournament was originally organised by the All England Croquet and Lawn Tennis Club and featured only the men's singles event. The venue was at the Worple Road site, which was the location for Wimbledon before it moved to its current location on Church Road in 1922.

62. Option (1) is correct.

Krishna III, a Rashtrakuta king, is known for his military campaigns, including his conquest of the Cholas. He defeated the Chola king and expanded the Rashtrakuta empire, marking a significant point in South Indian history.

63. Option (1) is correct.

The MPC (Marginal Propensity to Consume) and MPS (Marginal Propensity to Save) are related as:

$$MPC + MPS = 1$$

Given that MPC = 0.6, we can find MPS as:

$$MPS = 1 - MPC = 1 - 0.6 = 0.4$$

So, the likely value of MPS is 0.4.

The correct answer is 0.4.

64. Option (1) is correct.

Let's match the correct monuments with their respective states/UTs:

- Maharashtra: Elephanta Caves (located near Mumbai)
- Delhi: Jamali Qamali Mosque (located in Mehrauli Archaeological Park)
- Rajasthan: Hawa Mahal (located in Jaipur)
- Gujarat: Laxmi Vilas Palace (located in Vadodara)

65. Option (1) is correct.

The author of the book *The House of Blue Mangoes* is David Davidar. Published in 2002, this novel is set in South India and tells the story of a family over several generations, capturing the social and cultural dynamics of the region. It is Davidar's debut novel, gaining critical acclaim for its vivid storytelling and intricate portrayal of characters and history.

66. Option (3) is correct.

The novel *Untouchable* was written by Mulk Raj Anand. Published in 1935, it is a pioneering work in Indian English literature that highlights the plight of the lower castes in Indian society. The novel focuses on the life of a young Dalit boy named Bakha and critiques the social injustices of the caste system.

67. Option (3) is correct.

Under the Pradhan Mantri Fasal Bima Yojana (PMFBY), the maximum premium payable by farmers for horticulture

crops is 5%. This scheme aims to provide financial support to farmers in case of crop failure due to various reasons such as natural calamities, pests, or diseases, thereby helping to ensure their livelihood security.

68. Option (3) is correct.

Anorexia Nervosa is a psychological disorder characterised by an intense fear of gaining weight and a distorted body image, leading to an extreme refusal to eat food. It can result in severe undernutrition and various health complications. In contrast, Marasmus and Kwashiorkor are both forms of malnutrition due to lack of proper nutrition, particularly protein and calorie intake. Bulimia Nervosa involves cycles of overeating followed by purging behaviours.

69. Option (4) is correct.

The electronic configuration 2,8,1 corresponds to the element sodium (Na), which has an atomic number of 11. This means it has 2 electrons in the first shell, 8 electrons in the second shell, and 1 electron in the third shell. Chlorine has an electronic configuration of 2,8,7. Hydrogen has an electronic configuration of 1. Magnesium has an electronic configuration of 2,8,2.

70. Option (3) is correct.

The Aravalli is a mountain range in western India, extending through the states of Rajasthan, Haryana and Gujarat. It is one of the oldest mountain ranges in the world and forms a crucial geological and ecological feature in the region.

71. Option (1) is correct.

The correct formula for calculating the gross primary deficit is: Gross fiscal deficit – Net interest liabilities. The gross primary deficit is calculated by subtracting the net interest liabilities from the gross fiscal deficit. It represents the fiscal deficit excluding the interest payments on past borrowings.

72. Option (3) is correct.

The Reserve Bank of India (RBI) is not a constitutional body. It is a statutory body established under the Reserve Bank of India Act, of 1934. In contrast, the National Commission for Backward Classes, the Election Commission of India and the Comptroller and Auditor-General of India are constitutional bodies established under the Constitution of India.

73. Option (3) is correct.

James Chadwick is best known for his discovery of the neutron in 1932. This breakthrough significantly advanced the understanding of atomic structure and earned him the Nobel Prize in Physics in 1935. The neutron, a neutral subatomic particle found in the nucleus of atoms, plays a critical role in nuclear reactions and the stability of atoms.

74. Option (1) is correct.

Rubber is not a major cultivation in Punjab, as the state's climate and soil conditions are not suitable for rubber plantations. Rubber is primarily grown in tropical regions, and states like Kerala, Tamil Nadu and Meghalaya are known for significant rubber production due to their favourable climate and high rainfall.

75. Option (3) is correct.

Nhava Sheva (also known as Jawaharlal Nehru Port) and Haldia are satellite ports. A satellite port is developed to reduce the congestion of the main port by sharing its cargo and operational load. Nhava Sheva serves as a satellite port for Mumbai Port, while Haldia supports Kolkata Port.

76. Option (2) is correct.

The Government of India Act, of 1935 proposed the establishment of an All India Federation comprising provinces and princely states. However, this federation never came into existence as the princely states did not agree to join it. This Act also introduced provincial autonomy and was a significant step in the constitutional development of British India.

77. Option (1) is correct.

Onam is the most important and widely celebrated festival in Kerala. It is a harvest festival that marks the homecoming of the mythical King Mahabali. Celebrated with grandeur, it includes cultural events, boat races, flower decorations (Pookalam), traditional feasts (Onasadya) and various festivities reflecting Kerala's rich cultural heritage.

78. Option (3) is correct.

As the temperature rises, the kinetic energy of the particles increases, causing them to move faster. This is because temperature is a measure of the average kinetic energy of particles in a substance.

79. Option (2) is correct.

Ribosomes are essential cell organelles made up of ribosomal RNA (rRNA) and proteins. They are the sites of protein synthesis, where mRNA is translated into amino acid sequences to form proteins. Ribosomes can be found floating freely in the cytoplasm or attached to the endoplasmic reticulum. Their unique structure and inclusion of RNA make them vital for cellular functions and protein production.

80. Option (2) is correct.

Both Statement I and Statement II are true. Ashoka's Lion Capital at Sarnath consists of four lions mounted back-to-back on a circular abacus, which rests on a bell-shaped lotus. The State Emblem of India is adapted from this Lion Capital, but it excludes the bell-shaped lotus and instead includes the circular abacus showing four smaller animals (bull, horse, elephant, lion) and the motto "Satyameva Jayate."

81. Option (2) is correct.

In the first seven Five-Year Plans, India adopted an inward-looking trade strategy, which focused on self-sufficiency, import substitution and restricting imports to promote domestic industries. This approach aimed at reducing dependence on foreign goods and fostering growth in indigenous production through protectionist policies, tariffs and restrictions on foreign trade.

82. Option (1) is correct.

The Haryana team won the Women's U-18 Hockey title in the Khelo India Youth Games 2022. The tournament is part of India's efforts to promote sports at the grassroots level and to provide young athletes with a platform to showcase their talent.

83. Option (4) is correct.

The walls of the Great Stupa of Amaravati in the Lower Godavari region were adorned with bas-relief sculptures. These sculptures depict scenes from the life of the Buddha, various Jataka tales and other Buddhist themes. Bas relief is a sculptural technique where the figures project slightly from the background, creating a three-dimensional effect while remaining attached to the surface.

84. Option (1) is correct.

The Integrated Child Development Services (ICDS) Scheme primarily focuses on providing nutrition support to children, pregnant women and lactating mothers. It aims to improve the health, nutrition and development of children under six years of age and to provide supplementary nutrition, immunisation and health care services. The programme is a

holistic approach to tackle malnutrition and ensure overall child development.

85. Option (3) is correct.

L K Advani, the prominent Indian politician and senior leader of the Bharatiya Janata Party (BJP), authored an autobiography titled 'My Country My Life'. The book was published in 2008 and reflects his personal experiences, political journey and his vision for India.

86. Option (2) is correct.

Sulphur is not a good conductor of electricity. It is a non-metal, and non-metals typically do not conduct electricity well. On the other hand, gold, silver and aluminium are good conductors of electricity, with silver being the best conductor among them.

87. Option (3) is correct.

Humification is the process that occurs during decomposition in soil, where organic matter is broken down and converted into humus. This process enriches the soil with nutrients and improves its fertility. The other options—crystallisation, defragmentation and oxidation—are not directly related to the decomposition process in soil.

88. Option (2) is correct.

Pitt's India Act was passed in 1784. It was introduced by Prime Minister William Pitt the Younger to address the issues of governance and control over the British East India Company. The Act aimed to establish a system of dual control, where both the British government and the East India Company shared authority over India.

89. Option (3) is correct.

M Balamuralikrishna was a renowned Carnatic music vocalist, composer and multi-instrumentalist. He was known for his contribution to Carnatic music and was celebrated for his extraordinary vocal abilities and compositions in the tradition. He is widely regarded as one of the greatest musicians in India.

90. Option (1) is correct.

The correct match is: 1. a-ii, b-i, c-iv, d-iii

Explanation:

- Carnivores (ii. Secondary or tertiary consumers): Carnivores are secondary or tertiary consumers in the food chain, as they feed on other consumers.
- Producers (i. Green plants): Producers are organisms like green plants that produce their food through photosynthesis.
- Decomposers (iv. Bacteria): Decomposers like bacteria break down dead organic material and recycle nutrients in the ecosystem.
- Herbivores (iii. Primary consumers): Herbivores are primary consumers as they feed directly on producers (plants).

91. Option (4) is correct.

The estimated growth target of the Second Five-Year Plan in India was 4.5%. The plan, which was implemented between 1956 and 1961, primarily focused on the development of the industrial sector, particularly heavy industries. The target of 4.5% growth is aimed at promoting economic self-sufficiency and reducing the dependency on foreign aid.

92. Option (3) is correct.

India won the Bronze medal in the 2022 Asia Cup hockey tournament. The Indian men's hockey team secured the third position after defeating Japan in the third-place match, which was held in Jakarta, Indonesia.

93. Option (4) is correct.

Under Article 19(2) of the Indian Constitution, the rights guaranteed by Article 19 (such as freedom of speech, assembly, etc.) can be suspended during an emergency due to external aggression or war, but not due to internal disturbances or armed rebellion.

94. Option (2) is correct.

Under the Indian Councils Act of 1861, the individual members of the Executive Council were assigned their portfolios, marking a significant change in the governance structure of British India. This allowed for more specialised administrative roles within the Executive Council, a shift from the earlier practice where members had collective responsibility without distinct portfolios.

95. Option (4) is correct.

Andhra Pradesh recorded a sex ratio of 993 females per 1,000 males in the 2011 census, which was the highest among the states listed here. The sex ratio in India overall was 940 females for every 1,000 males.

Bihar: Sex ratio – 918

Rajasthan: Sex ratio – 928

Uttar Pradesh: Sex ratio – 912

96. Option (1) is correct.

India hosted the Asian Games for the second time in 1982. The games were held in New Delhi, marking a significant milestone in India's sporting history. The event took place from 19th November to 4th December, 1982 and saw the participation of athletes from 33 countries. This was a key moment in promoting sports in India and improving its infrastructure, with the creation of facilities like the Jawaharlal Nehru Stadium.

97. Option (1) is correct.

Tropical cyclones typically originate over warm ocean waters, and in the case of India, they are most commonly formed in the Bay of Bengal, the Arabian Sea and the Indian Ocean. These regions provide the necessary warm water and atmospheric conditions for the formation of cyclones.

98. Option (1) is correct.

Bade Ghulam Ali Khan, a renowned Hindustani classical vocalist, belonged to the Patiala Gharana. He was one of the most famous figures in classical music and played a significant role in popularising the Patiala style of vocal music, known for its rich and elaborate renditions of ragas.

99. Option (3) is correct.

The birth anniversary of Lord Jhulelal, celebrated by the Sindhi community, is known as Cheti Chand. This festival marks the occasion of Lord Jhulelal's birth and is widely celebrated by Sindhi Hindus, with prayers, processions and community gatherings in his honour. It usually falls in March or April, according to the Hindu calendar.

100. Option (1) is correct.

Antoni van Leeuwenhoek is considered the founding father of microbiology for his ground breaking work in discovering the invisible world of microbes using a homemade microscope in the late 17th century. Leeuwenhoek was the first to observe and describe bacteria, protozoa and other micro organisms, paving the way for the development of microbiology as a scientific field.

101. Option (3) is correct.

In the sentence 'He goes hard with one and all', the idiom "goes hard" means to become difficult or problematic for someone, leading to trouble or pain if they don't take action.

102. Option (2) is correct.

By whom was Bruno taken for a walk? The sentence is converted to passive voice by making the object "Bruno" the subject, changing the verb "took" (past tense) to "was taken," and replacing "Who" with "By whom" to maintain the question format. This ensures that the tense and meaning of the original sentence are preserved. Other options are incorrect as they either use the wrong tense or alter the meaning of the sentence.

103. Option (3) is correct.

In the given sentence: "The solicitor suggested that they should solve the dispute over the land", the reporting verb "suggested" is appropriate for the original imperative sentence, which expresses a proposal or recommendation. The word "should" accurately conveys the solicitor's intention of resolving the dispute. The other options are incorrect because "wished" (option 1) changes the meaning to express a desire, "might" (option 2) indicates possibility rather than a suggestion, and "ordered" (option 4) misrepresents the tone of the original statement.

104. Option (1) is correct.

The correct sequence is BACD. Tea was originated in China by its ruler, Shennong. However, the most consumed tea in the world is Indian tea. India also has the credit of being the world's largest producer. This is because of the tropical and sub-tropical climate present here. The sentences reflect the most logical order, starting with the origin of Tea in China, but on the contrary, the most consumed tea in the world is Indian tea. In addition, India is the world's largest producer.

105. Option (2) is correct.

'Reliable' means able to be trusted, that is trustworthy. Thus, the most suitable antonym is 'Untrustworthy'.

106. Option (1) is correct.

In the sentence 'He will come when he will be ready', the error is in 'he will be', which will be replaced by 'he is'. This is because in time clauses, simple present tense is used after 'when'. The correct sentence is: He will come when he is ready.

107. Option (2) is correct.

In the sentence, 'Our neighbour told my brother to keep an eye on their pet dog in their absence', 'keep an eye on' is an idiom which implies to keep something under careful observation. Here, the neighbour wants the brother to watch over their pet dog in their absence.

108. Option (4) is correct.

Keep body and soul together. This idiom means to manage to survive or sustain oneself with basic necessities despite difficulties. The sentence discusses how extreme inflation has made it challenging to afford essential commodities for daily living, aligning perfectly with the idiom's meaning. Other options are incorrect because a blessing in disguise option (1) refers to something that seems bad but turns out to be good, break a leg option (2) is used to wish someone good luck, and costs an arm and a leg option (3) refers to something being very expensive, which doesn't directly fit the context of survival.

109. Option (4) is correct.

In the sentence 'My idea can be key idea for cracking difficult conflicts of extremely high level', the error is in "key idea", which will be preceded by 'a'. The phrase "extremely high level" requires an article "an" before "extremely". The correct sentence is: My idea can be a key idea for cracking difficult conflicts of an extremely high level.

110. Option (2) is correct.

The correct sequence is ACBD. Men usually make more decisions and certainly the most important ones since men play a bigger role in earning a livelihood in most parts of the world they have a major say in economic matters. A reinforces the assertion made in A ; the reason is provided in C , which stands completed after being connected with B.

111. Option (2) is correct.

The correct sentence is: Technology has made it possible for us to reach out to more students, and it has also made it possible for us to deliver the same lessons in a much more resourceful manner. The word 'resourceful' means having the ability to find quick and clever ways to overcome difficulties. In other words, in an imaginative way.

112. Option (3) is correct.

France will win the FIFA cup 2022. The original sentence is in the passive voice (The FIFA cup 2022 will be won by France), and to convert it into active voice, the subject ("France") takes the place of the doer of the action. The future tense "will be won" in passive voice changes to "will win" in active voice, preserving the tense and meaning. Other options are incorrect because they either alter the tense (wins in option (1) and would win in option (2)) or use the progressive tense (will be winning in option (4)), which does not match the structure or intent of the original sentence.

113. Option (1) is correct.

The sentence "Vishnu and his friends were listening to the radio all morning" is free of all errors.

114. Option (3) is correct.

The sentence "PIEZO2 plays an critical role along with Piezo1 to regulate a important physiological process for brain to understand" is incorrect. the word 'important' must be preceded by 'an', not 'a' because of the vowel sound of the word. Similarly, 'brain' will be preceded by the definite article "the" since it refers to a specific brain, namely the one being discussed in the context. The correct sentence is: PIEZO2 plays a critical role along with Piezo1 to regulate an important physiological process for the brain to understand.

115. Option (2) is correct.

'Admiration' means respect and warm approval. So, the most suitable choice for the antonym is 'Contempt' which means disregard for something that should be considered disrespect.

116. Option (3) is correct.

The sentence "Elegance and intelligence had the two most important traits of young ladies" is incorrect, here, 'had the' is inappropriate, and hence will be replaced by 'are the'. This is because "are" correctly agrees with the plural subject "Elegance and intelligence" which states a fact/ opinion, so it is written in the simple past tense form. The correct sentence is: Elegance and intelligence are the two most important traits of young ladies.

117. Option (4) is correct.

'Hind' means located at or near the back of something, in other words 'rear'. 'Fore' 'anterior' and 'ventral' are related to the front.

118. Option (3) is correct.

The word constant means unchanging or continuous, so its antonym is changing, which conveys variability or lack of permanence. The other options are not correct because boring refers to dullness, steady has a meaning similar to constant, and friendly does not relate to the idea of change or consistency in this context.

119. Option (1) is correct.

She said, "I am seeing my brother tomorrow." In direct speech, the verb tense and time expressions of the reported speech must match the context of the original statement. In the sentence, "She said she was seeing her brother the following day", "was seeing" changes to "am seeing" to fit the present context of the direct speech, and "the following day" changes to "tomorrow". The correct reporting verb is 'said'.

120. Option (2) is correct.

The customer asked the tailor if he would have the dress ready by Tuesday. In indirect speech, the future tense "will" changes to "would" to maintain proper tense agreement. The question format "Will you" in direct speech is transformed into "if he would" in indirect speech. Option (1) is incorrect because "should" changes the meaning of the original question. Option (3) is incorrect because the future tense "will" should be back shifted to "would" in indirect speech. Option (4) is incorrect as it changes the meaning of the question by introducing "would like."

121. Option (3) is correct.

The sentence "The earth has a exceptional structure which may have helped in life's arrival" is incorrect, here, 'has a' is inappropriate, and hence will be replaced by 'has an'. This is because "The earth" refers to a specific planet, so the definite article suits the need. "An" must be correctly used before a word with a vowel sound "exceptional". The correct sentence is: The earth has an exceptional structure which may have helped in life's arrival.

122. Option (4) is correct.

The correct sequence is R, P, S, Q. The Artemis mission will explore the south pole of the Moon where ice has been confirmed to exist within craters and where no man has ever been before. R starts with the topic - The Artemis mission, P complements the exploration by providing details, the adverb clause in S completes RP, which ends in Q.

123. Option (1) is correct.

The correct sequence is R, S, P, Q. Museums are always treasure troves of information showcasing objects of historic, scientific and cultural interest by taking us back in time. R provides the topic - Museums, which makes sense when juxtaposed against S 'are treasure troves of information', this is elucidated in P and Q.

124. Option (4) is correct.

The homework is being done by her. In passive voice, the object of the active sentence becomes the subject, and the verb tense is adjusted accordingly. The sentence "She is doing the homework" is in the present continuous tense, so in the passive voice, the verb "is being done" is used to match the tense, and the object "homework" becomes the subject. Option (1) is incorrect because it uses the past tense ("was done"), while option (2) uses the past continuous tense ("was being done"), which is not appropriate here. Option (3) uses the present perfect tense ("has been done"), which does not match the original sentence's tense.

125. Option (2) is correct.

Reena is loved by Malathi. In passive voice, the object of the active sentence becomes the subject, and the verb tense is adjusted accordingly. The sentence "Malathi loves Reena" is in the present simple tense, so in the passive voice, the verb "is loved" is used to match the tense, and the object "Reena" becomes the subject. Option (1) is incorrect because it uses the past tense ("was loved"), while options (3) and (4) use continuous tenses, which are not appropriate for the present simple tense of the original sentence.

126. Option (4) is correct.

The idiom 'a damp squib' means something that is disappointing because it is not as exciting or effective as expected. While 'hitting the sack' implies it's time to go to bed; 'a mare's nest' means a complex or confused situation. While 'up against the wall' means a critical position in which failure seems imminent.

127. Option (2) is correct.

The correct sentence is: Online shopping refers to purchasing goods available on the world wide web. You have different websites which have a huge assortment of products that you can choose from. The word 'assortment' means a miscellaneous collection of things or people. The wide variety of products in display through online shopping justifies the aptness of the word.

128. Option (4) is correct.

Some youngsters were helping the wounded woman. In active voice, the subject (some youngsters) performs the action. The sentence "The wounded woman was being helped by some youngsters" is in the past continuous passive form, and to convert it into active voice, the sentence should use the past continuous active form "were helping" to reflect the ongoing action. Option (1) is incorrect because it changes the tense to the present perfect. Option (2) uses the past simple tense, which doesn't maintain the continuous aspect of the original sentence. Option (3) changes the structure and meaning of the sentence entirely.

129. Option (1) is correct.

The correct sentence is: It is terrible that education systems all over the world are being held in captivity due to poverty, both at the governmental and family levels, despite the fact that education is claimed to be so important for human progress and the revitalisation of global economies. Revitalisation means bringing new life, energy, or vitality to something; dismantling is the act of taking something apart or breaking it down. Abrogation suggests the formal or official cancellation, devastation connotes great destruction.

130. Option (3) is correct.

To change narration, the changes must revolve around tense, usage of pronouns, modals, reporting verb. In the sentence, "She asked me why I was not eating", the pronoun changes from "I" to "you"; the sentence changes to a question. Next, insert a comma before the statement and the first letter of the statement should be in capital. Moreover, tense changes from past to present. The structure is like: if + noun + verb + object. So, the correct answer is: She said, "Why are you not eating?"

131. Option (2) is correct.

The sentence "I have known her for many years. This time, she took unusual decision in unprejudiced way" is incorrect, here, 'unusual decision' and ' unprejudiced way' are inappropriate, and hence will be preceded by 'an' because it must be used before a word with a vowel sound " unusual " and "unprejudiced". The correct sentence is: I have known her for many years. This time, she took an unusual decision in an unprejudiced way.

132. Option (4) is correct.

The correct sentence in past continuous tense is: They were watching TV all evening. The past continuous tense, also known as the past progressive tense, describes ongoing actions in the past. It has the structure: was/were + verb + ing.

133. Option (1) is correct.

Sastri sings devotional songs superbly. The original sentence "Devotional songs are sung superbly by Sastri" is in the passive voice, using the present simple tense. To convert it into active voice, the subject (Sastri) is placed at the beginning of the sentence, and the verb is adjusted to the present simple tense ("sings"). Option (2) is incorrect because it uses the present continuous tense ("is singing"), which changes the meaning of the original sentence. Option (3) uses the present perfect continuous tense ("has been singing"), which also changes the tense. Option (4) uses the present perfect tense ("has sung"), which is not a direct conversion of the original sentence's tense.

134. Option (2) is correct.

The correct sentence is: I am quite busy. Quite is an adverb meaning "to a considerable extent or degree", this modifies the adjective 'busy'. While 'quiet' refers to something being calm or silent.

135. Option (2) is correct.

The minister had invited a selected group of activists before the announcement of the strike. In the passive voice, the sentence "A selected group of activists had been invited by the minister" uses the past perfect tense. To convert it into active voice, one must retain the past perfect tense "had invited" while making the subject (the minister) the doer of the action. Option (1) uses the past perfect continuous tense, which changes the meaning. Option (3) uses the simple past tense, which is not appropriate for the past perfect context. Option (4) uses the past continuous tense, which also alters the meaning.

136. Option (3) is correct.

My parents do not force me to study hard. The original sentence "I am not forced to study hard by my parents" is in the passive voice, using the present simple tense. To convert it into active voice, one must keep the present simple tense and make "my parents" the subject who performs the action. Option (1) uses the past tense "did not force," which changes the meaning of the original sentence. Option (2) uses the future tense "will not force," which is also incorrect. Option (4) uses the present continuous tense "are not forcing," which does not match the original sentence's tense.

137. Option (1) is correct.

Raju ordered Reghu to stay back. In reported speech, the imperative sentence is typically changed into a statement using the reporting verb in the past tense. The original sentence "Raju said to Reghu, 'Stay back'" is an order, and in reported speech, the verb "said to" is replaced with "ordered" to convey the commanding tone. The verb "stay" is kept in its base form. Option (2) is incorrect because it uses the past perfect tense "had ordered," which is not necessary here. Option (3) uses the present tense "orders," which does not match the original past tense. Option (4) uses the present perfect tense "has ordered," which is also not appropriate for this context.

138. Option (2) is correct.

People know that some students grow wise early. The sentence "Some students are known to grow wise early" is in the passive voice, and to change it to active voice, the subject (people) becomes the doer of the action. In the passive voice, the phrase "are known" is transformed to "know" in active voice, maintaining the general sense of the sentence. Option (1) is incorrect because "have been knowing" is not a proper construction in English. Option (3) and option (4) change the

meaning of the original sentence, particularly with “grew wise” and “students grew early,” which does not align with the original context.

139. Option (1) is correct.

She said that she had finished her work. In indirect speech, when the reported speech is in the present perfect tense (“I have finished”), it changes to the past perfect tense (“she had finished”) to maintain proper tense agreement. The reporting verb “said” remains in the past tense, and “that” is used to introduce the reported speech. Option (2) and option (3) incorrectly change the tense to future, while option (4) keeps the present perfect tense, which is not the correct transformation for indirect speech.

140. Option (4) is correct.

The correct sequence is CADB. He has lost all his teeth consequently, he cannot eat hard food. C introduces the subject ‘he’, followed by the verb ‘lost’, which is subsequently followed by the effect ‘consequently, he cannot eat hard food.’ Thus, the order exhibits the most logical cause-effect relationship.

141. Option (2) is correct.

In the sentence, “Even amidst the all-pervasive silence, the noise inside her head seemed incessant”, the word incessant connotes continuing without pause or interruption. The correct answer is : To continue without any interruption.

142. Option (3) is correct.

The word ‘Concur’ means to agree or approve of something. In the given sentence, ‘resist’ means to oppose, which is the opposite of what ‘concur’ suggests.

143. Option (3) is correct.

In the sentence, “He will has been helping me with tending to my plants”, ‘will has been’ is incorrect, and will be replaced by ‘has been’, because the latter phrase best aligns with the usage of present perfect tense, which is used for actions that were recently completed but are still relevant to the present.

144. Option (4) is correct.

The correct answer is: The troll, the boy shared on social media created a big laughter. “The” must be used before to a specific troll; “on” is the correct preposition to use with “social media.” Though “laughter” is an uncountable noun, but to denote the phrase “big laughter”, it must be preceded by the indefinite article.

145. Option (3) is correct.

My friend asked me if I knew the recipe of mango ice cream. In indirect speech, the question is transformed by using “if” or “whether” to introduce the reported speech. The tense of the verb also shifts from “know” (present) to “knew” (past) to maintain the correct sequence of tenses. Option (1) is incorrect because it uses “that” instead of “if,” which is not appropriate for yes/no questions in indirect speech. Option (2) is incorrect because it keeps “know” in the present tense, which does not follow the proper tense shift. Option (4) is incorrect because it uses “that” and does not shift the tense correctly.

146. Option (3) is correct.

The idiom “under the weather” means feeling sick or unwell. The correct answer is : feeling slightly ill.

147. Option (2) is correct.

“Admonish” means warn or reprimand someone firmly. Since this is a negative word, one needs to find a positive word to justify as an antonym. The correct answer is: applaud, meaning to praise.

148. Option (1) is correct.

The phrase “ever for” in segment D is grammatically incorrect. The correct phrase should be “ever since,” which is used to indicate an ongoing state or feeling from a specific point in the past. The other segments—A, B and C—are grammatically correct. Segment D contains the error because “ever for” does not convey the intended meaning in standard English usage.

149. Option (1) is correct.

The correct answer is: The development of the region also depended on the generosity of the corporate contribution via a social responsibility scheme. Rapaciousness means an intense and often ruthless desire to seize or control something. So, the most appropriate antonym is ‘generosity’. All other options exhibit negative qualities.

150. Option (4) is correct.

She explained that she was playing the keyboard. In indirect speech, the present continuous tense “I am playing” changes to the past continuous tense “she was playing” to maintain the correct sequence of tenses when the reporting verb (“explained”) is in the past tense. Option (1) and option (3) are incorrect because they retain the present continuous tense, which is not suitable when shifting to indirect speech. Option (2) changes the tense to the past perfect continuous (“had been playing”), which alters the original meaning of the sentence.

151. Option (1) is correct.

In the sentence “The patient absconded from the hospital at dawn”, ‘absconded’ means to leave hurriedly and secretly, typically to avoid detection or arrest.

152. Option (4) is correct.

The given assertive sentence, “ She said to me, “I shall come to meet you tomorrow”, when changed in indirect speech, uses “that” after the reporting verb. Moreover, modal ‘shall’ changes to ‘would’, and ‘tomorrow’ changes to ‘the next day’. So, the correct answer is: She told me that she would come to meet me the next day.

153. Option (4) is correct.

It is time for tea to be had. In passive voice, the focus shifts to the object of the action, and the verb form is adjusted accordingly. The phrase “to have tea” in active voice changes to “for tea to be had” in passive voice, maintaining the original meaning of the sentence. Option (1) is incorrect because “Tea is to be taken by it” is awkward and does not convey the intended sense. Option (2), while grammatically correct, omits the “time” context, altering the meaning. Option (3) introduces a new idea about preparing tea, which is not part of the original sentence.

154. Option (1) is correct.

The chef baked the cake in the kitchen. In active voice, the subject performing the action (the chef) comes first, followed by the verb in the appropriate tense (“baked”) and the object (the cake). The original sentence is in the past simple passive voice (“was baked”), so the verb “baked” in the past simple tense is used in active voice. Option (2) is incorrect because it inappropriately makes “the kitchen” the subject. Option (3) is incorrect as it changes the tense to present continuous. Option (4) uses past continuous tense, which is also not correct for the given sentence.

155. Option (4) is correct.

The correct sentence is: They could not reach the railway station before the train left. The blank will take simple past tense which is used to describe actions or situations that were completed in the past.

156. Option (3) is correct.

Children should respect their parents. In active voice, the subject performing the action (children) comes first, followed by the modal verb "should" and the base form of the verb "respect." This maintains the meaning and structure of the original sentence in active voice. Option (1) changes the construction and introduces "are to," which alters the tone. Option (2) and option (4) incorrectly use continuous forms ("shall be respecting" and "should be respecting"), which are not equivalent to the original statement.

157. Option (2) is correct.

The correct sequence is SURPTQ. There are a number of different categories of objects and processes under the umbrella term of art which need to be explored. Art is typically divided into two areas: fine art (such as painting, sculpture, music and poetry), and the applied arts (such as pottery, weaving, metal working, furniture making and calligraphy). Fine art is categorised as something which only has an aesthetic or conceptual function. Applied arts require an object to be functional, as well as beautiful. In the twentieth century, artists began to challenge the established notion of art. They recognised that their work belonged to the higher social classes who had the wealth to purchase art and the leisure time to enjoy it. S introduces the subject-art and the need for exploration. U elaborates this term of art being categorised into fine art and applied arts. R elucidates the first category, while P elaborates the second one. TQ form a pair because the pronoun 'they' in Q refers to the artists.

158. Option (1) is correct.

The correct sentence is: The patient couldn't survive the injuries and succumbed with death. Here, 'succumbed with' will be replaced by 'succumbed to' death. The phrase 'succumbed to' means to stop fighting against something.

159. Option (2) is correct.

She said, "I can bake cookies." In converting the indirect sentence "She said that she could bake cookies" to direct speech, the modal verb "could" reverts to its present form "can" because the reporting verb "said" is in the past tense, and there is no indication of a past reference for the ability. Option (1) introduces "had said," which changes the tense of the reporting verb unnecessarily. Option (3) uses "says," which is inconsistent with the original past-tense reporting verb. Option (4) replaces "can" with "may," altering the meaning of the sentence.

160. Option (1) is correct.

"We have been waiting for the bus for over an hour," they said. When converting the indirect speech "They said that they had been waiting for the bus for over an hour" to direct speech, the past perfect continuous tense ("had been waiting") reverts to the present perfect continuous tense ("have been waiting") because the context suggests the action was ongoing up to the point of speaking. This matches the immediacy and continuity implied in the original statement. Option (2) changes the tense to simple past, which does not align with the original meaning. Option (3) shifts to past perfect, which alters the aspect of the action. Option (4) incorrectly uses the present continuous tense, which is grammatically inconsistent with the original sentence.

161. Option (1) is correct.

The correct sentence is: Over and above being hard working, he is thoroughly honest. The phrase 'Over and above' means 'in addition to.' This implies that not only is he hard working, but also honest.

162. Option (2) is correct.

"Amplify" means to increase the size or effect of something. 'Exaggerate' is a synonym of the word, while the correct antonym is 'lessen'.

163. Option (4) is correct.

The given assertive sentence, "She said, "He said, "I have finished my homework" when changed to indirect speech uses "that" after the reporting verb. Moreover, tense changes from present perfect (have finished) to past perfect (had finished). So, the correct answer is: She said that she had finished her work.

164. Option (1) is correct.

The correct sentence is: He was the cleverest man I ever knew. The part 'most cleverest' will be replaced by 'cleverest'. When an adjective possesses its superlative form, then 'most' is not added before it.

165. Option (4) is correct.

"To get wind of" means to learn a piece of information, especially when it has been a secret. The correct answer is: To hear a piece of information that someone was trying to keep secret.

166. Option (2) is correct.

The correct answer is: You have said that, as he took money from you many times, he owes you five thousand rupees altogether. "Altogether" is an adverb meaning "in total." "All together" refers to things being grouped or gathered in one place. So, 'all together' will be replaced by 'altogether'.

167. Option (2) is correct.

"Vanquish" means to defeat somebody completely in a contest, war, etc, i.e., Conquer.

168. Option (4) is correct.

An amateur is someone who engages in a pursuit, study, science, or sport as a pastime rather than as a profession. Thus, the most suitable antonym is 'Professional'.

169. Option (1) is correct.

"Ignoramus" implies a person who does not know much. So, the most suitable synonym is 'Stupid'.

170. Option (4) is correct.

The correct answer is: It became a known fact that they most often played techno music at every party. OR It became a known fact that they often played techno music at every party. "Most played" doesn't make sense, as it must modify an adjective or adverb to indicate the frequency.

171. Option (3) is correct.

The correct answer is: Earthquakes represent a highly consequential and perilous category of natural disasters. Natural disasters refer to a natural events such as floods, earthquakes, or hurricanes that cause great damage or loss of life. Artificial disasters are man-made, not initiated by nature.

172. Option (2) is correct.

The correct answer is: An earthquake refers to the abrupt release of accumulated strain energy within the Earth's crust. An earthquake is the shaking of the Earth's surface resulting from a sudden release of energy in the lithosphere. So 'energy' is the most befitting choice.

173. Option (4) is correct.

The correct answer is: An earthquake refers to the abrupt release of accumulated strain energy within the Earth's crust, leading to seismic shaking that propagates outward from the epicentre. An epicentre is the point on the earth's surface where the effects of a sudden movement (earthquake) are felt most strongly.

174. Option (3) is correct.

The correct answer is: Earthquakes exhibit a range of magnitudes, encompassing both imperceptible tremors and catastrophic events capable of causing extensive urban devastation. 'Extensive' means of great extent; wide, broad. The context clarifies that earthquakes are capable of causing damage and devastation on a large scale.

175. Option (1) is correct.

The correct answer is: Earthquakes can also arise as a consequence of volcanic activity. Moreover, these phenomena have diverse impacts that disrupt both individuals' livelihoods and physical assets. The cause behind the occurrence of earthquakes is mentioned – volcanic activity. While the result/consequence is an earthquake.

176. Option (3) is correct.

The correct answer is: Frogs are the amphibians. It indicates that they are capable of living both in water and on land. Owing to the fact that frogs are amphibians, they are skilled in living both in water and on land.

177. Option (2) is correct.

The correct answer is: They find quick bugs, with the assistance of their long tacky tongues. Since frogs have long tacky tongues, they are able to find quick bugs; this implies that it is with Thebaid of these tongues, that these creatures can find quick bugs.

178. Option (2) is correct.

The correct answer is: The normal frog contains a toxic substance, which it radiates from its skin, when gone after. 'Radiates' means to spread abroad or around as if from a centre. Here, the skin acts as a centre point from where a toxic substance gets radiated.

179. Option (2) is correct.

The correct answer is: However, they rarely experience serious consequences. Cane toads are extremely large toads that are laced with drugs. The poison, a toxic substance, which it radiates from its skin affects both canines and felines. However, they do not bear serious implications on the frogs.

180. Option (3) is correct.

The correct answer is: Because indigenous people use their toxic excretions to poison the tips of arrows and blow darts, the frogs are frequently referred to as poison arrow frogs or poison dart frogs. Since frogs are frequently referred to as poison arrow frogs or poison dart frogs, this toxic substance from frogs is used to poison the tips of arrows and blow darts.

181. Option (1) is correct.

The correct answer is: For most of us who are born and live in India, social inequality and exclusion are facts of life. It is presumed from the statement that social inequality results in divisiveness and prohibition.

182. Option (3) is correct.

The correct answer is: We see beggars on the streets and on railway platforms. If we look closely at the passage, there is a dominance of the people from the lower strata. Moreover, the

people at the end of this exclusion are the beggars. No other option captures this uniqueness.

183. Option (3) is correct.

The correct answer is: We see young children labouring as domestic workers, construction helpers, cleaners and helpers in streetside restaurants (dhabas) and tea-shops. No other option is appropriate to fix here.

184. Option (3) is correct.

The correct answer is: We are not surprised at the sight of small children, who work as domestic workers in middle class urban homes, carrying the school bags of older children to school. Given the grim picture as depicted by the writer, where young children work hard in the role of domestic workers, construction helpers, cleaners and helpers in streetside restaurants (dhabas) and tea-shops; it is definitely not surprising that of small children, who work as domestic workers in middle class urban homes, carrying the school bags of older children to school.

185. Option (1) is correct.

The correct answer is: It does not immediately strike us as unjust that some children are denied schooling. These morbid details of children labouring in different roles come as the truth, and this injustice and inequality do not come as a blow to us immediately.

186. Option (4) is correct.

The correct answer is: Research on infections over the past few decades has focused on hospitals, day-care facilities and schools, but little attention was paid to the home. "Little" refers to a very small amount of something, often implying that it is insufficient or not enough. While "a little" is more positive than "little," suggesting that the amount, though small, is adequate or acceptable.

187. Option (3) is correct.

The correct answer is: Today, the increase of foodborne illness and a growing need for home health care have focused interest on hygiene and cleanliness in the home. Clearly, the increase of foodborne illness makes it a pressing need to focus on home health care. So the need is serious, thus, 'growing' is apt.

188. Option (4) is correct.

The correct answer is: 'Hygiene' refers to conditions or practices by which people maintain or promote good health by keeping themselves and their surroundings clean. 'Hygiene' is a practice that entails the endorsement of good health, and it can be attained when surroundings are kept clean.

189. Option (1) is correct.

The correct answer is: Personal hygiene and household cleanliness practices affect the risk of spreading infectious disease. 'Risk of' is the correct phrase.

190. Option (2) is correct.

The correct answer is: A framework for developing practical home strategies to manage risk from infections is required. 'Hygiene' is a practice that entails the endorsement of personal hygiene and household cleanliness practices. These practical home strategies are the need of the hour to manage risk from infections.

191. Option (3) is correct.

As evinced in the statement "Furthermore, it helps in effective money management, making financial decisions, and achieving financial stability", stability means the state or quality of being steady and not changing. Thus, the opposite will be related to change. So 'Volatility' is the perfect choice, which means a tendency to change quickly.

192. Option (1) is correct.

As suggested in the passage, "Financial illiteracy leads to budget mismatch, higher expenses than income, accumulation of debts, poor credit score, being victims to financial frauds and other negative consequences". So all the options except financial discipline are dealt with here.

193. Option (2) is correct.

The writer asserts that financial literacy is an important tool for managing money effectively. Financial literacy helps in understanding financial concepts better and enables one to manage their finances efficiently. Hence, a strong foundation of these financial skills will help in achieving various life goals like retirement. Thus, the author of the above passage agrees that effective money management skills enable early retirement. Option (1) is stated to the contrary. Option (3) is illogical and unwarranted. Option (4) contradicts the argument of the passage.

194. Option (3) is correct.

The tone of the passage is informative because the writer explores and educates financial literacy, its importance and the skills involved and other financial concepts, like budgeting, investing and debt management. The writer never expresses his opinion on the same.

195. Option (3) is correct.

The writer gives information about the importance of financial literacy in managing money, making financial decisions, which ensures one's financial wellbeing and also protects individuals from financial frauds. Therefore, the most appropriate title for the passage is: The Importance of Financial Literacy.

196. Option (3) is correct.

A descriptive passage is a focused and detail-rich account of a specific topic. It provides detailed information about several aspects related to cinema, societal sensibilities and censorship. Thus, the structure of the passage is descriptive.

197. Option (1) is correct.

As stated in the part "A word that had originally been offensive became suddenly unoffensive, most likely as a result of the changed sensitivities of American culture that made it possible to update the Motion Picture Production Code", it is obvious that the word, which had originally been offensive, became unoffensive suddenly because of changed sensitivities of American culture.

198. Option (2) is correct.

The statement "Due to the word's offensive nature and consequent prohibition by the 1930 Motion Picture Production Code, sometimes known as the 'Hays Code' makes it apparent that "Damn" was interpreted as offensive in American Society in the 1930s.

199. Option (2) is correct.

The answer is made obvious in "The CBFC is required to certify that a movie, in whole or in part, does not jeopardise India's sovereignty and integrity, jeopardise its security and relations with foreign states". Thus, the CBFC has to certify and control the content shown in a movie to not jeopardise India's sovereignty and integrity.

200. Option (3) is correct.

The passage primarily discusses how cinema can influence societal values, beliefs and sensibilities by touching upon films, like *Gone with the Wind* and certain terms which were offensive to society's sensibilities. It takes us through a film's effects on people and society and the role of CBFC in regulating movies according to the evolving social and cultural context. Thus, the passage based upon the impact of cinema on people's sensibilities.